

7a

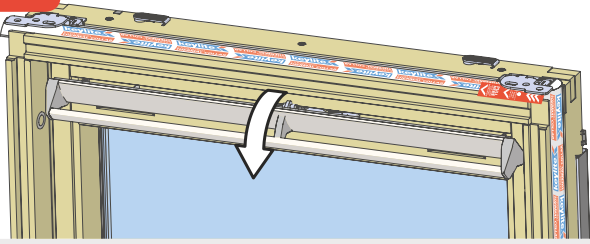

7b

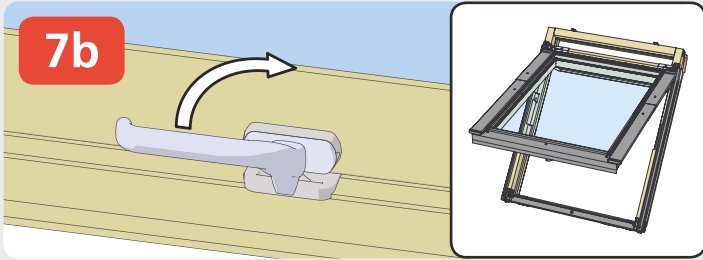

8

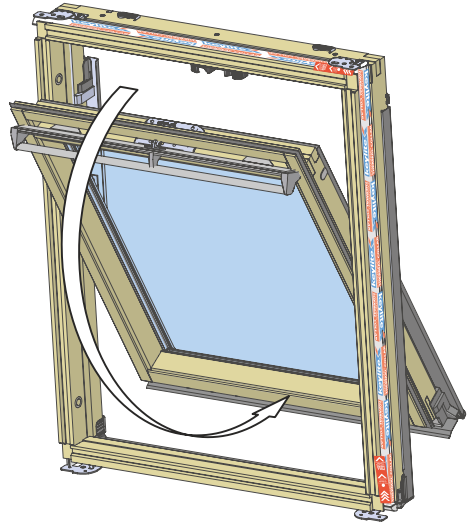

9

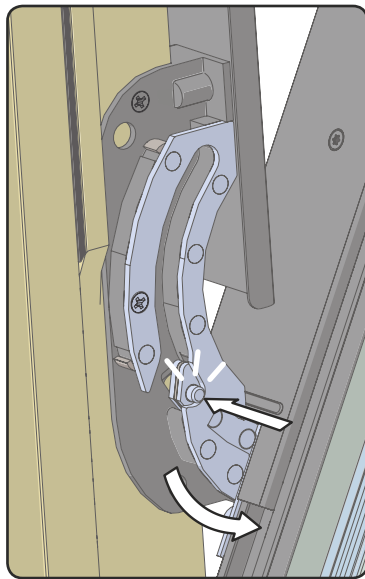
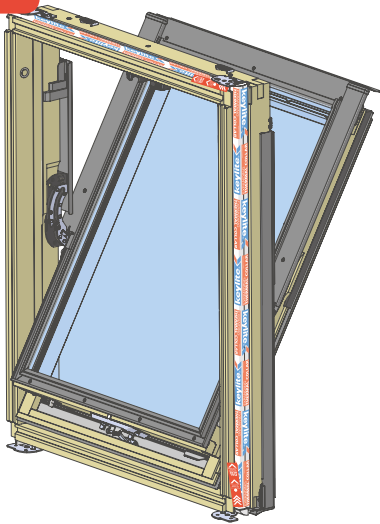

10

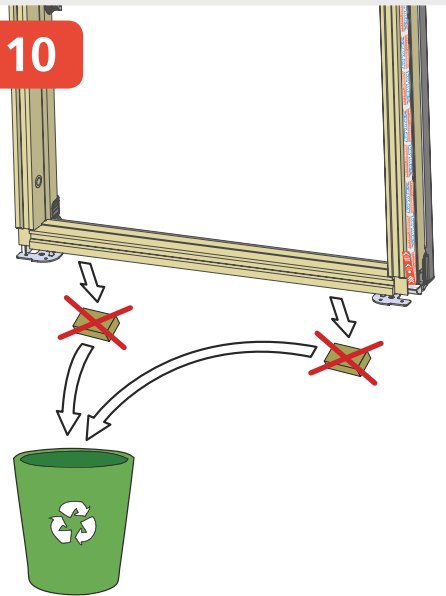

11

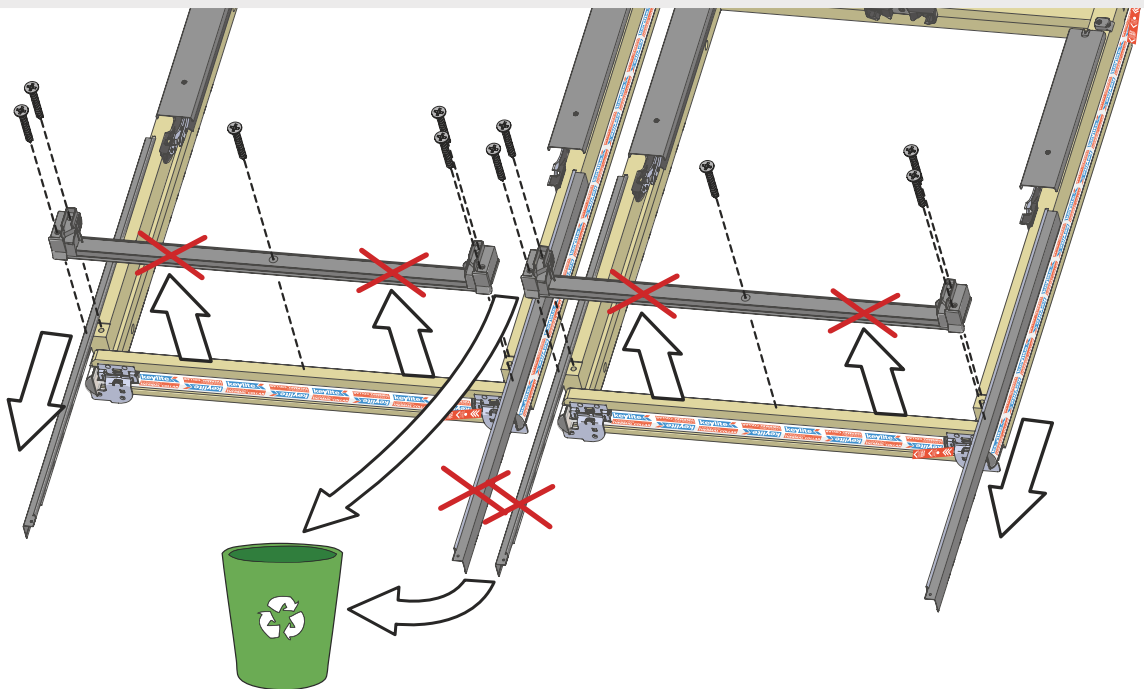

12

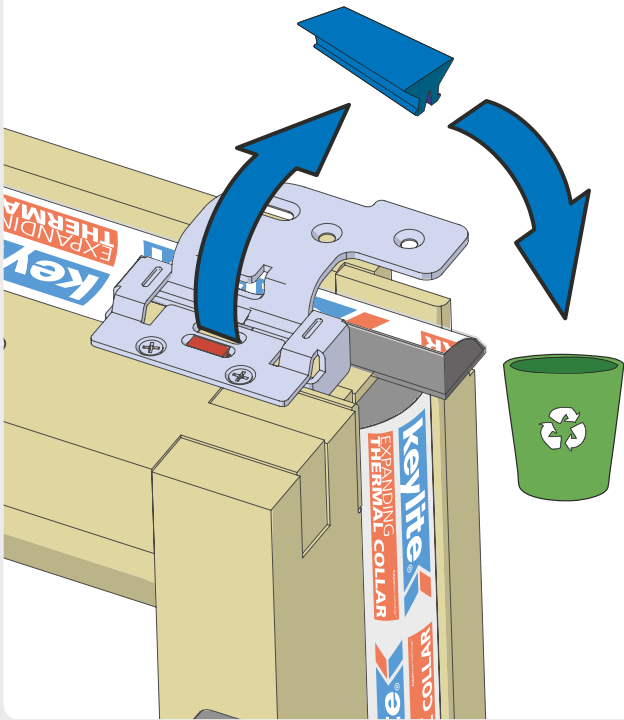

13

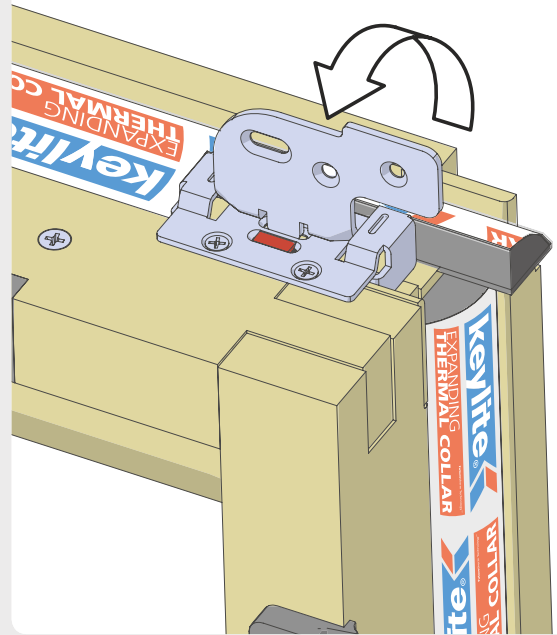

14

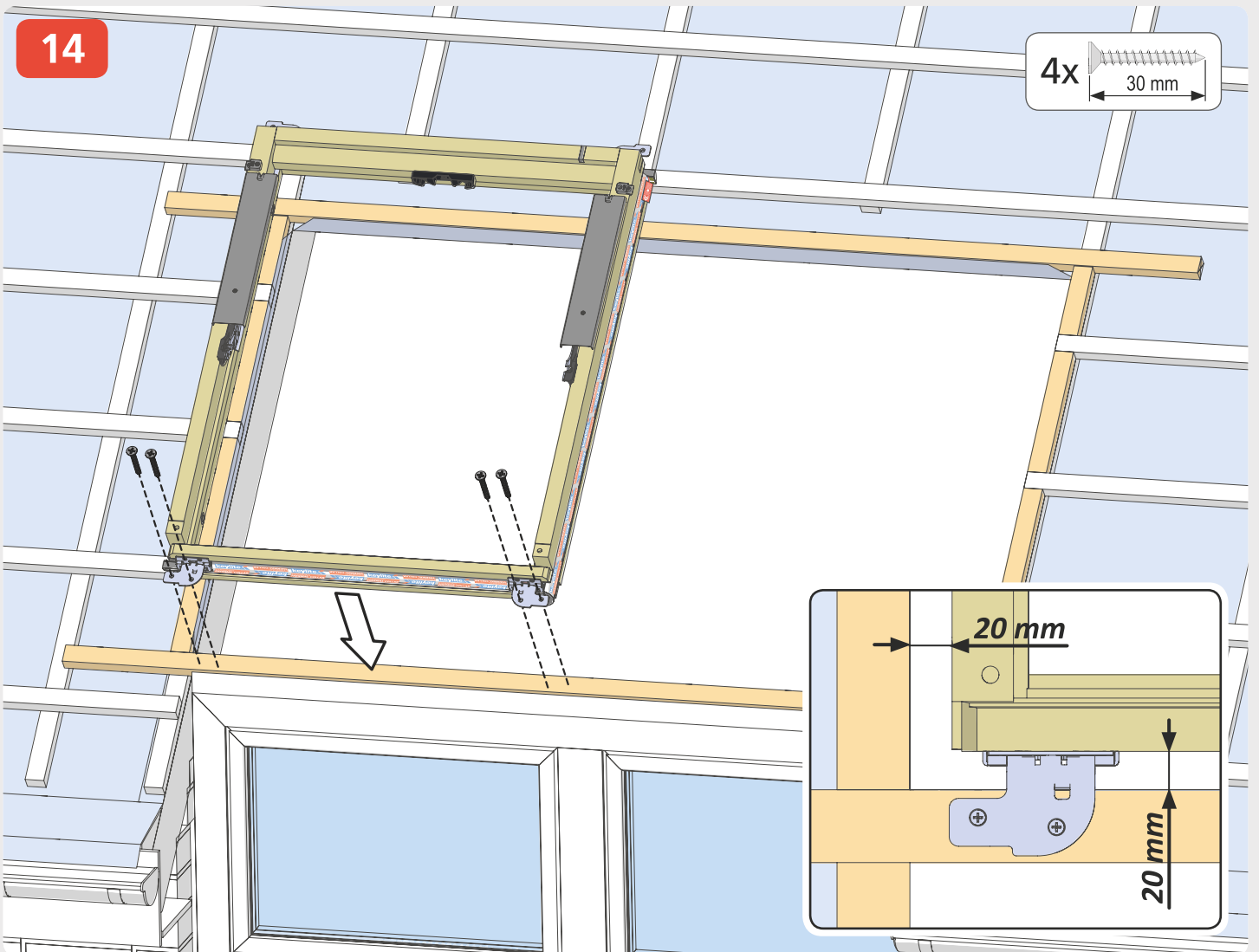

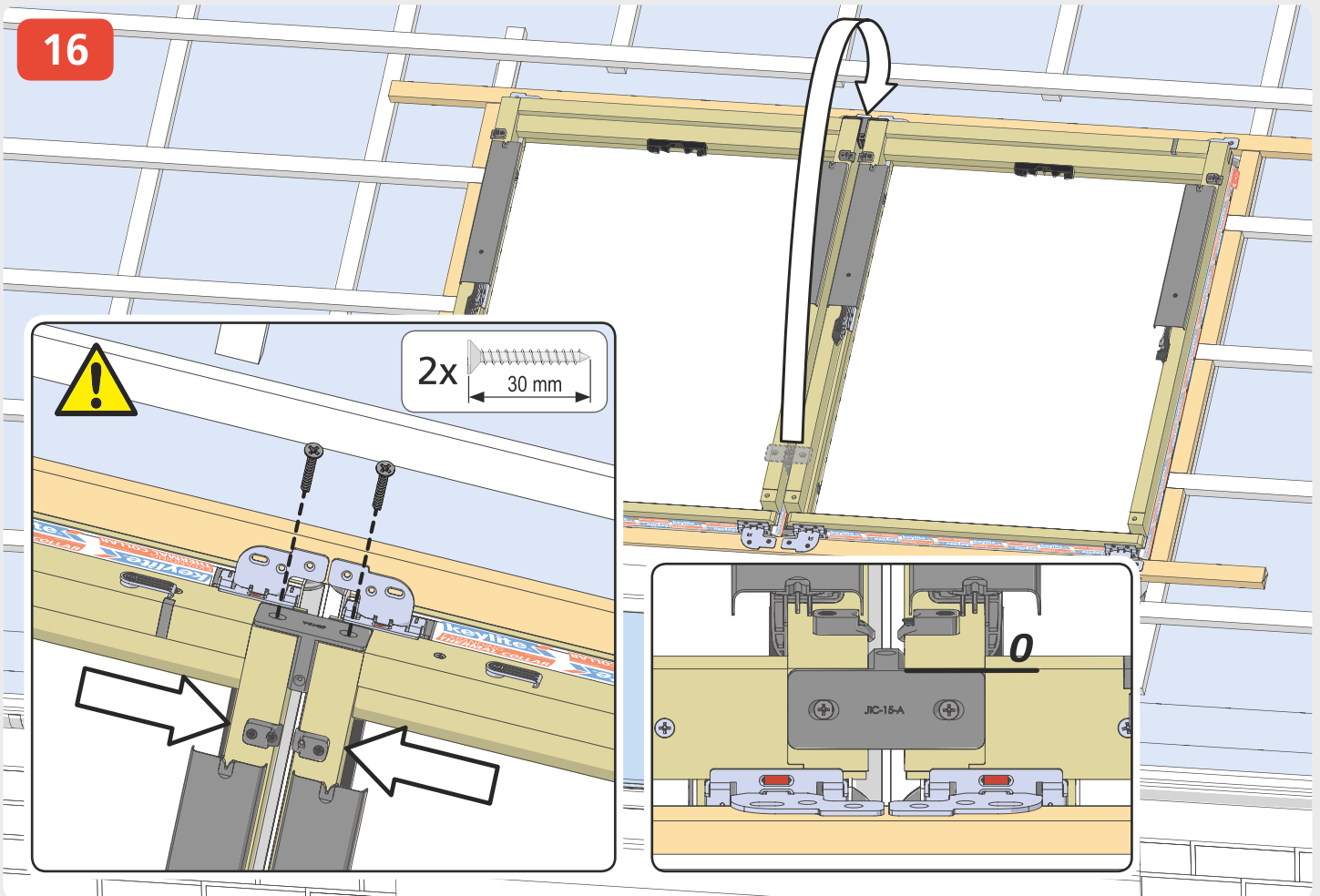
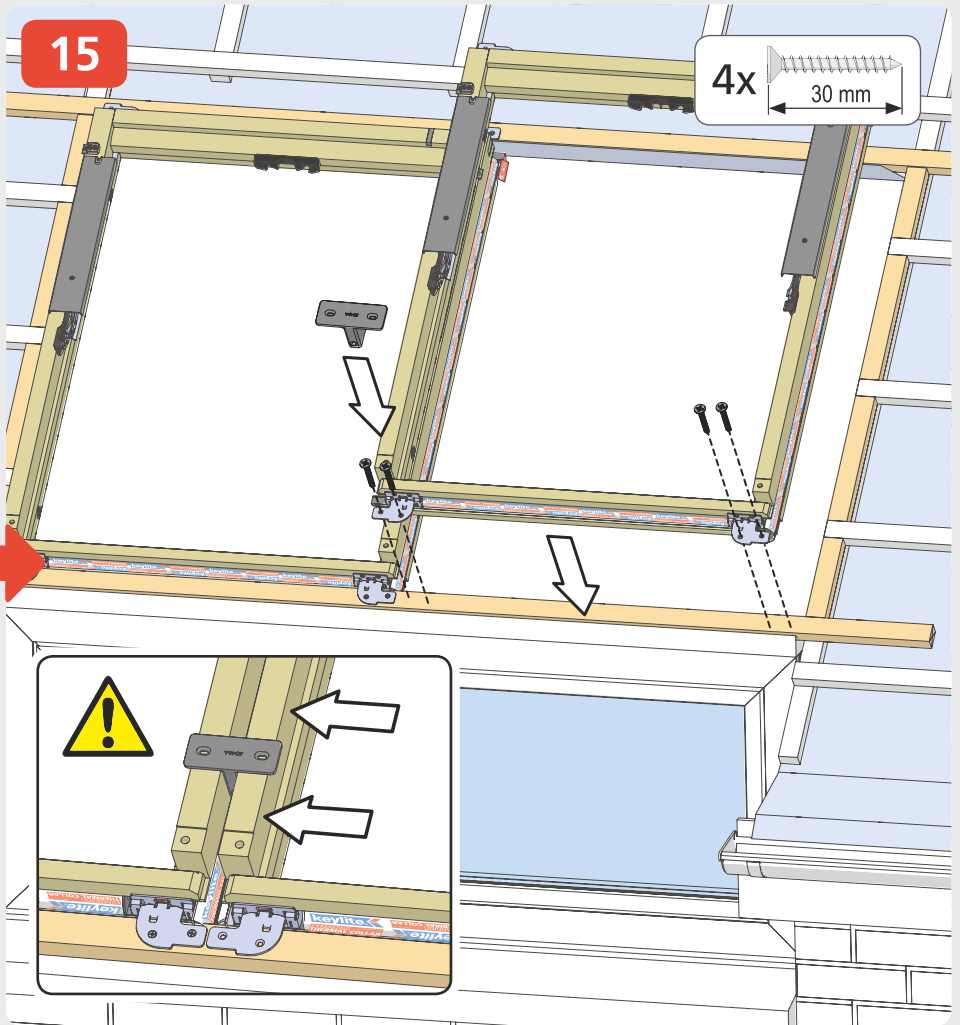
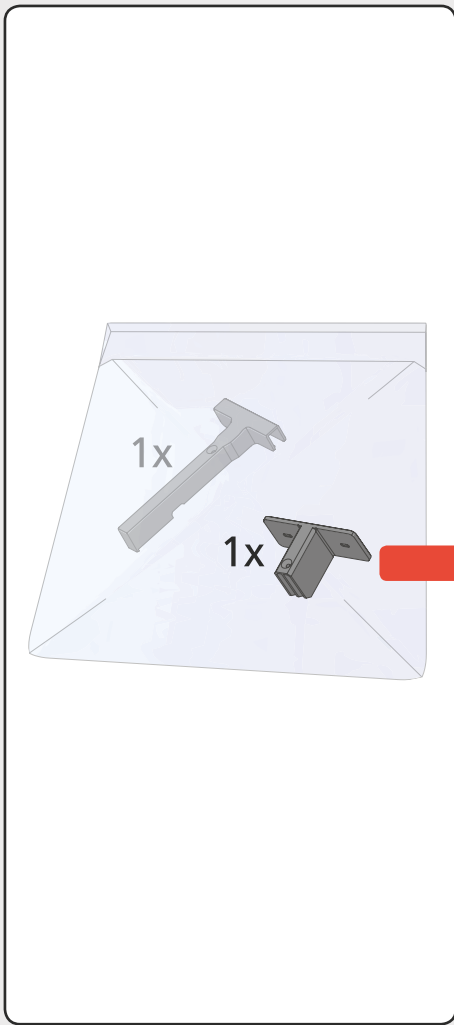

17

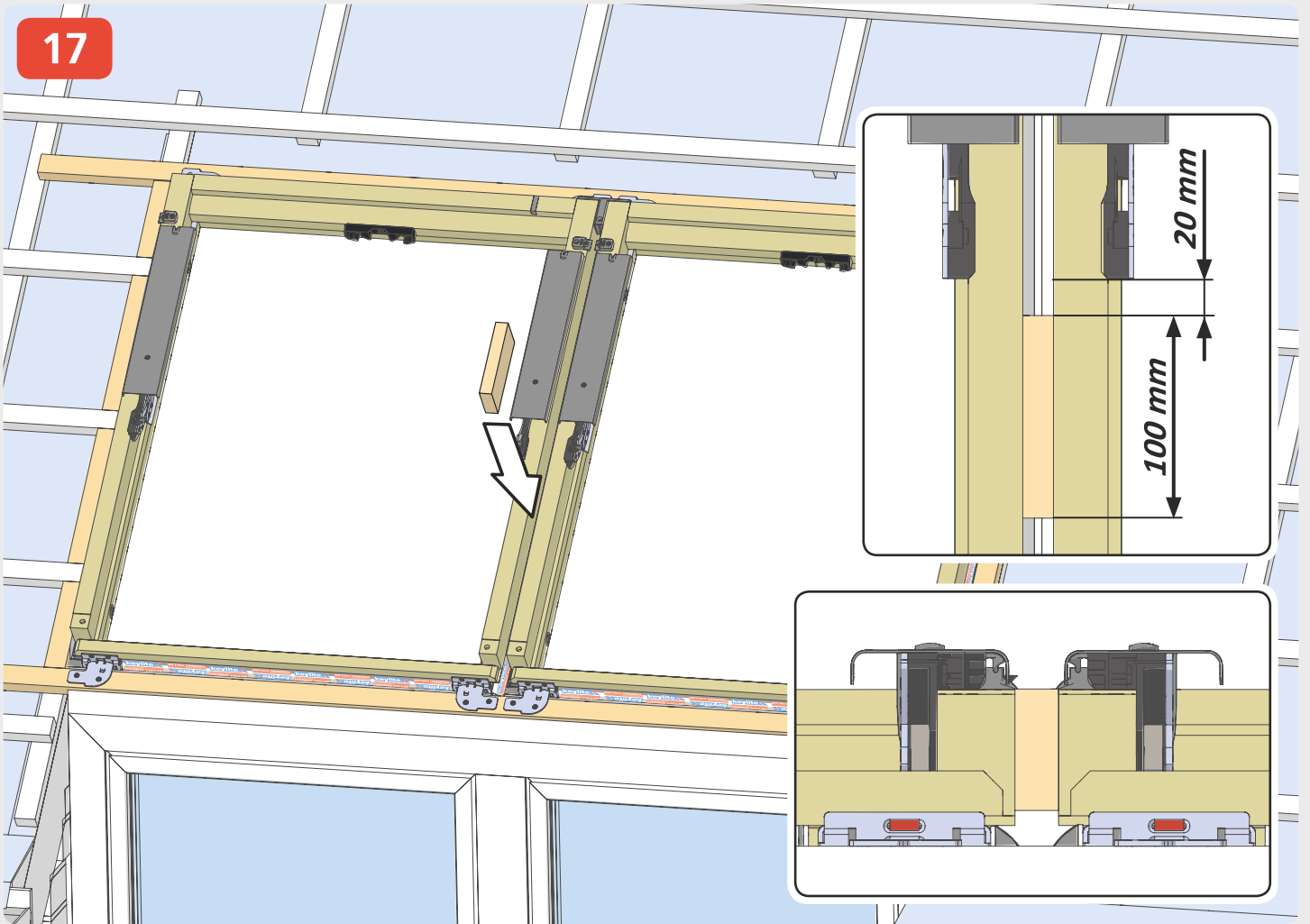

18

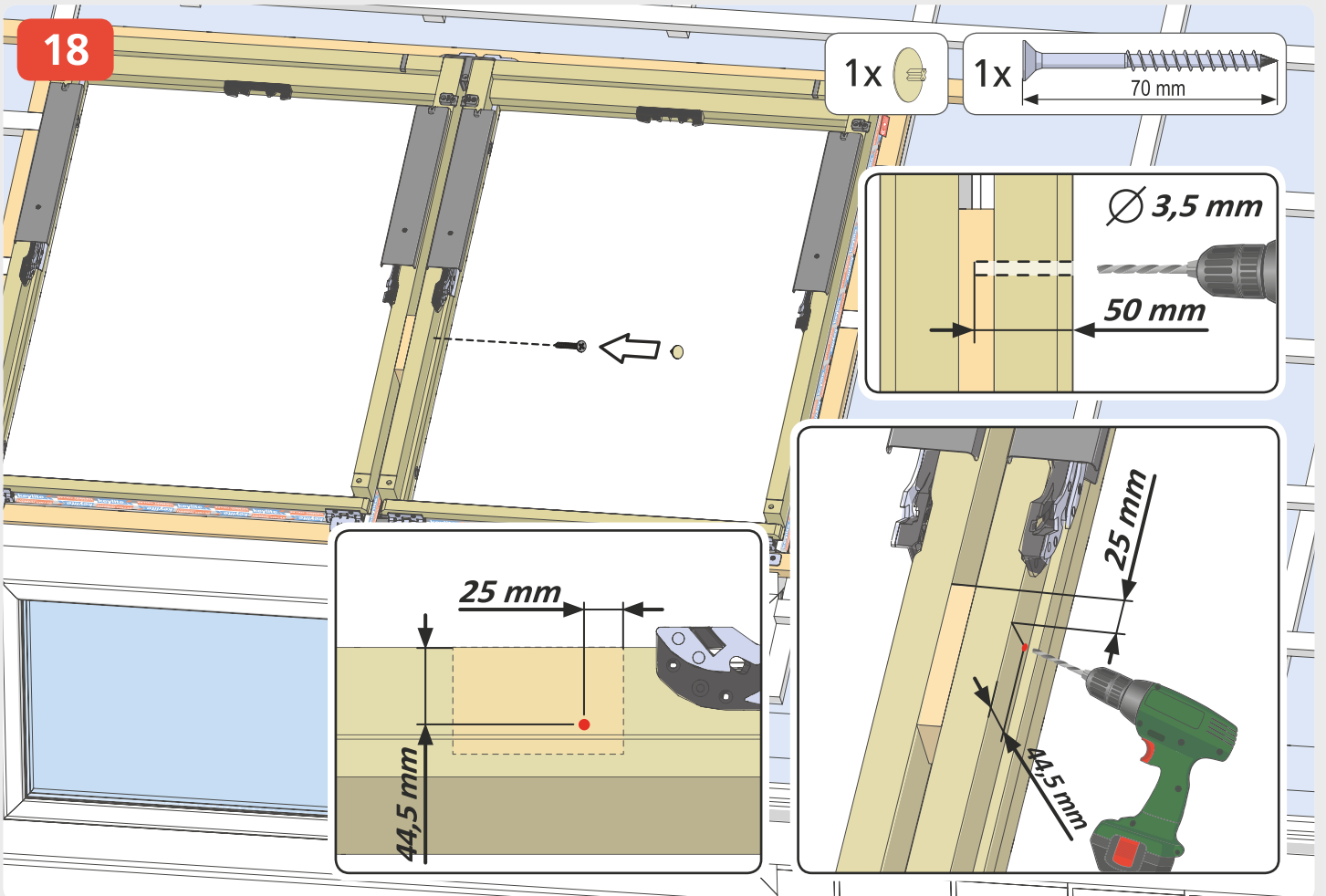

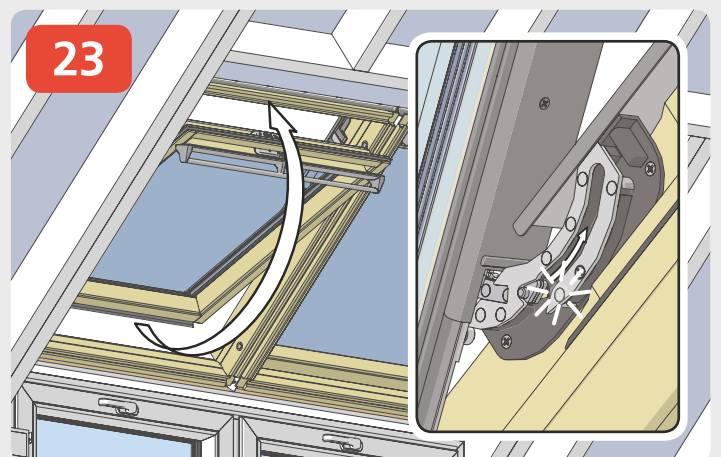
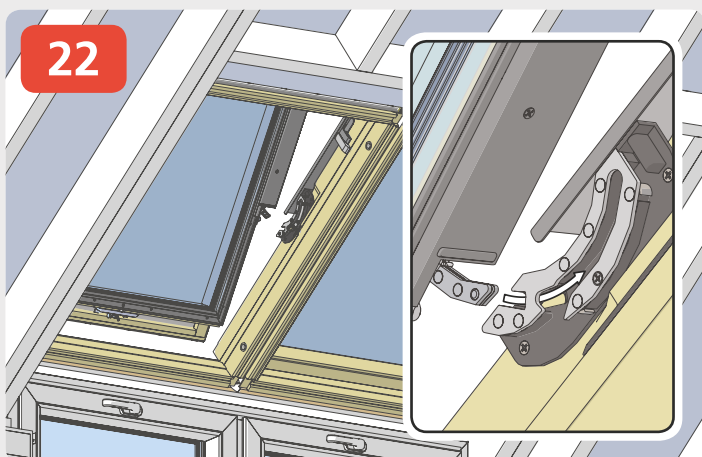
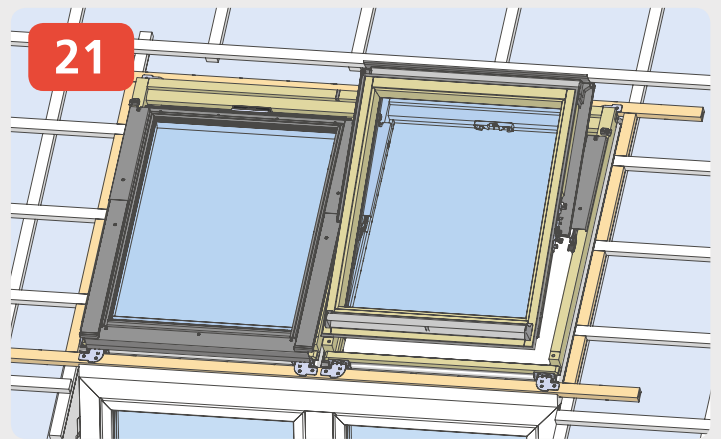
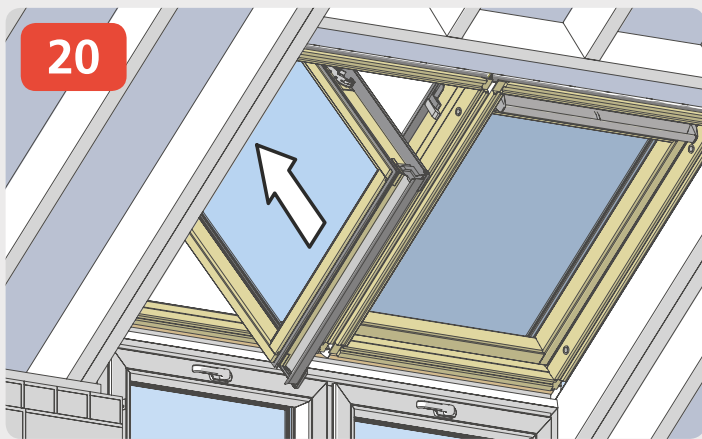
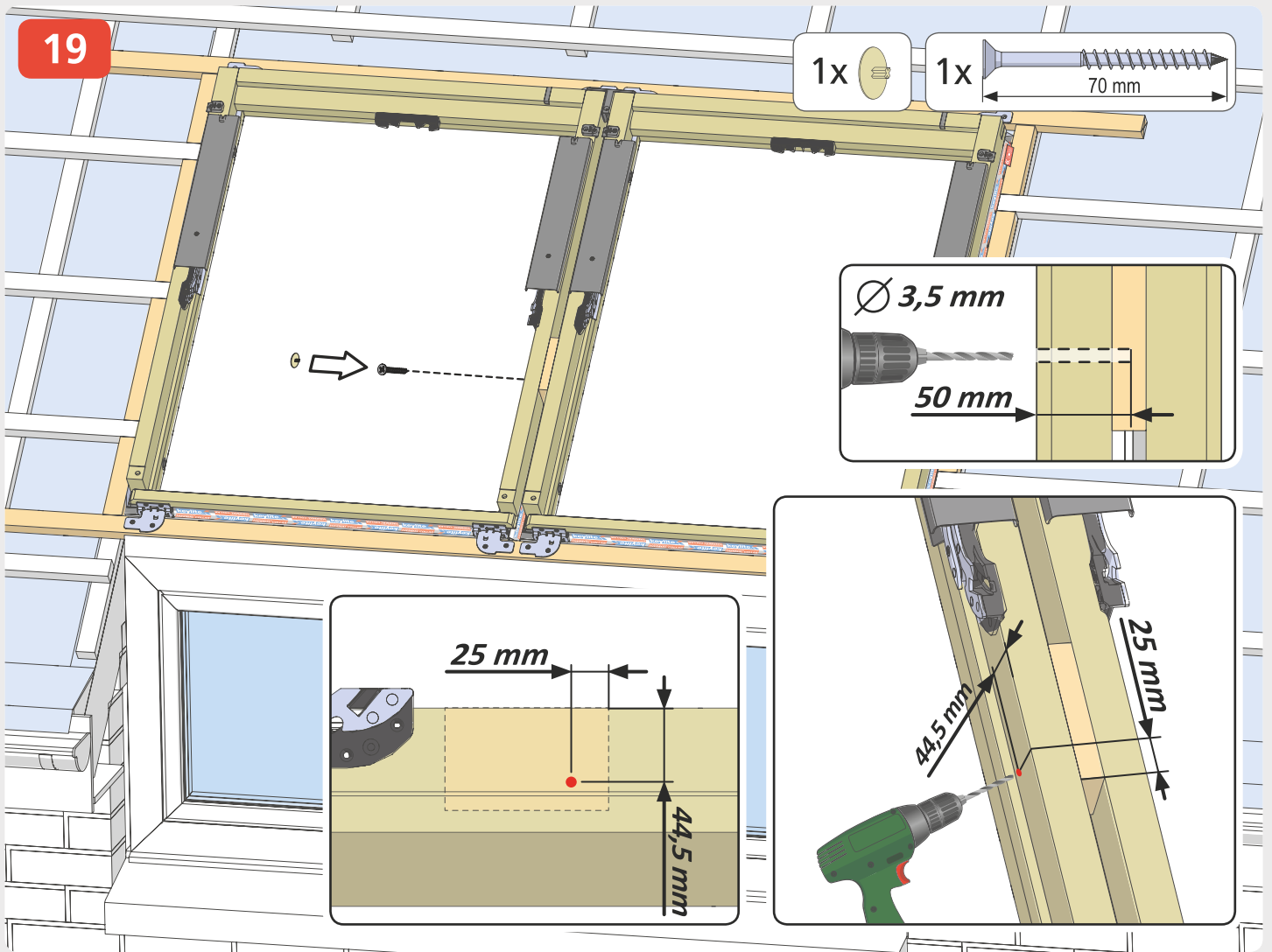

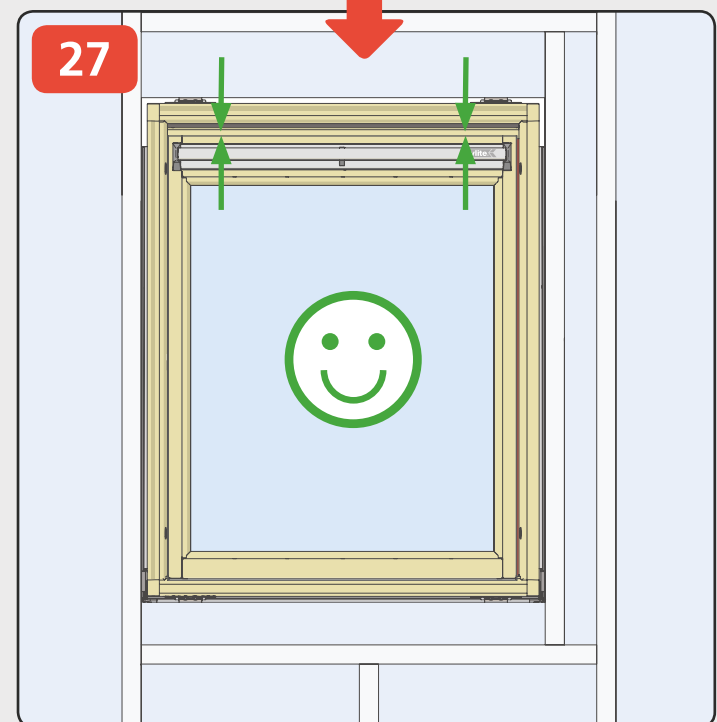
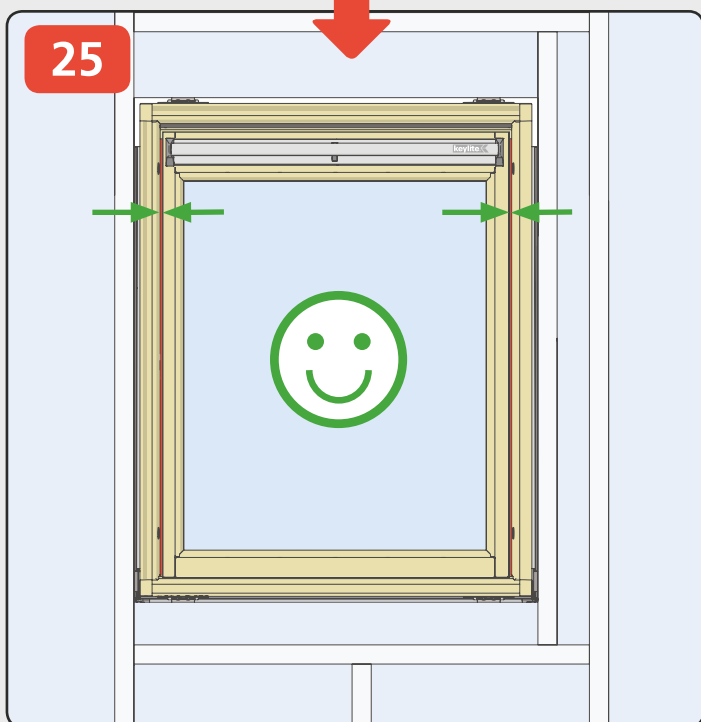
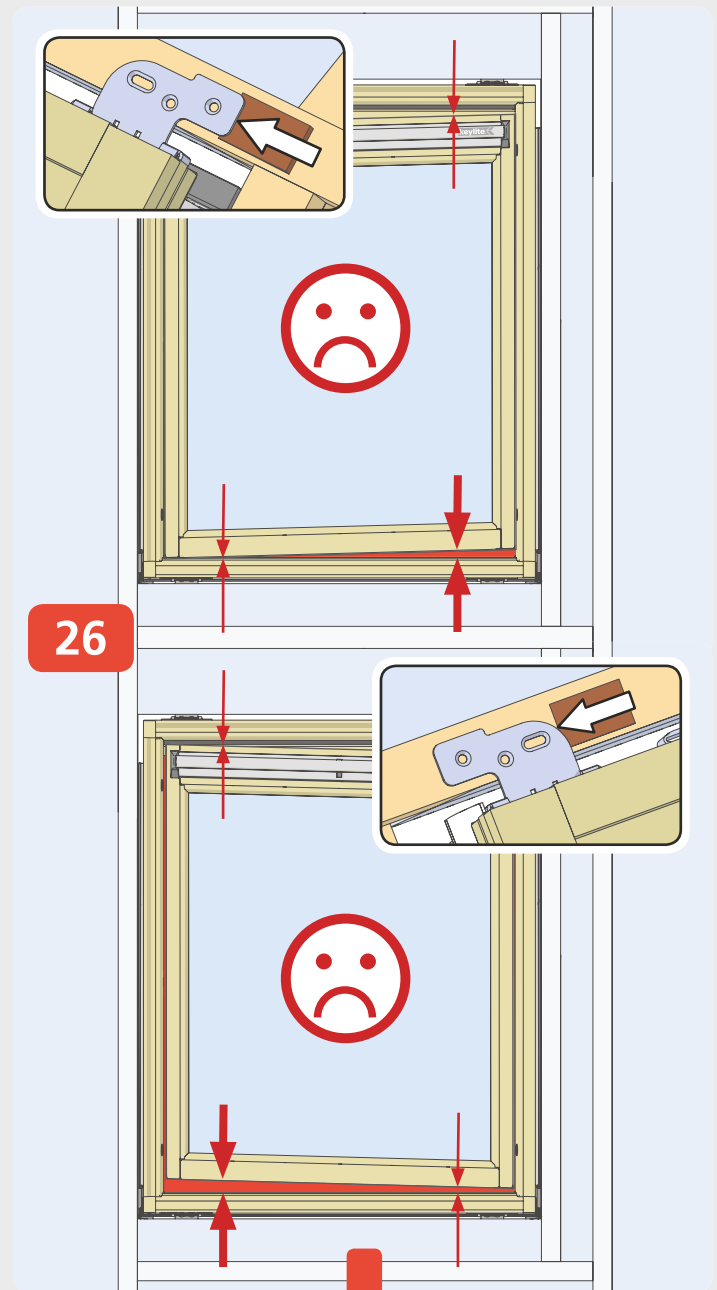
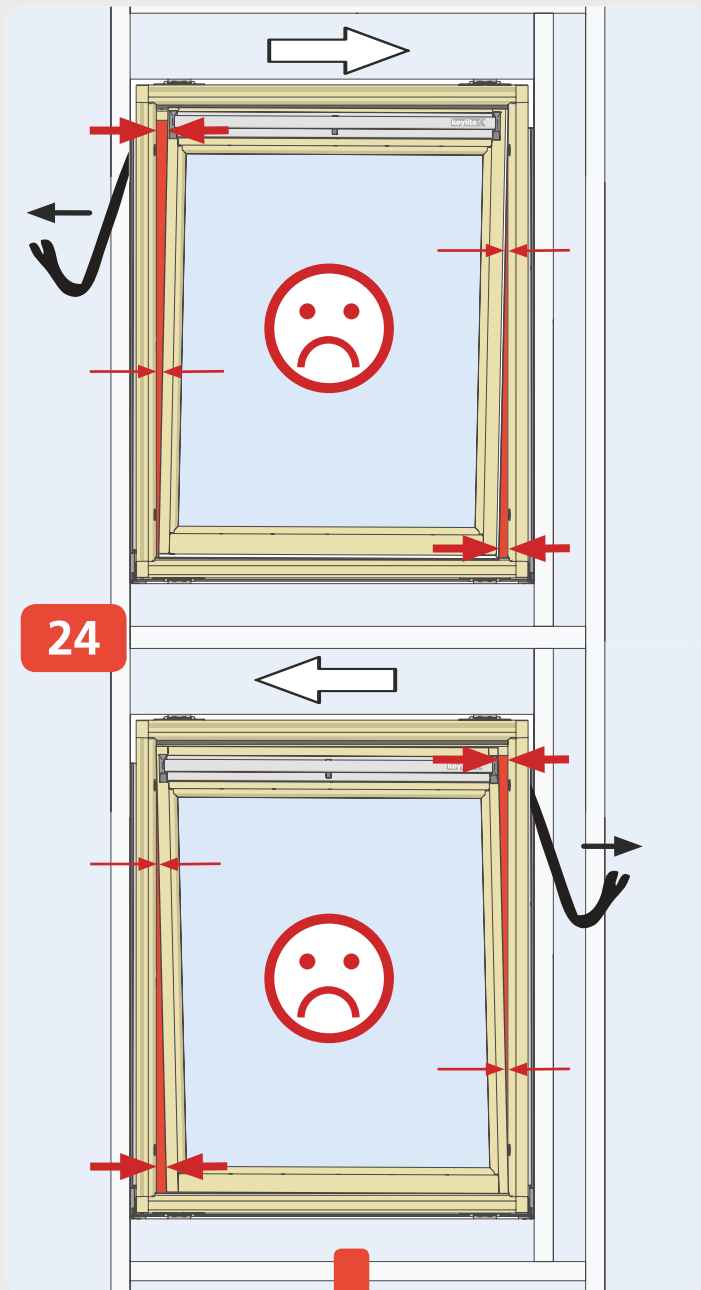

28

8x 

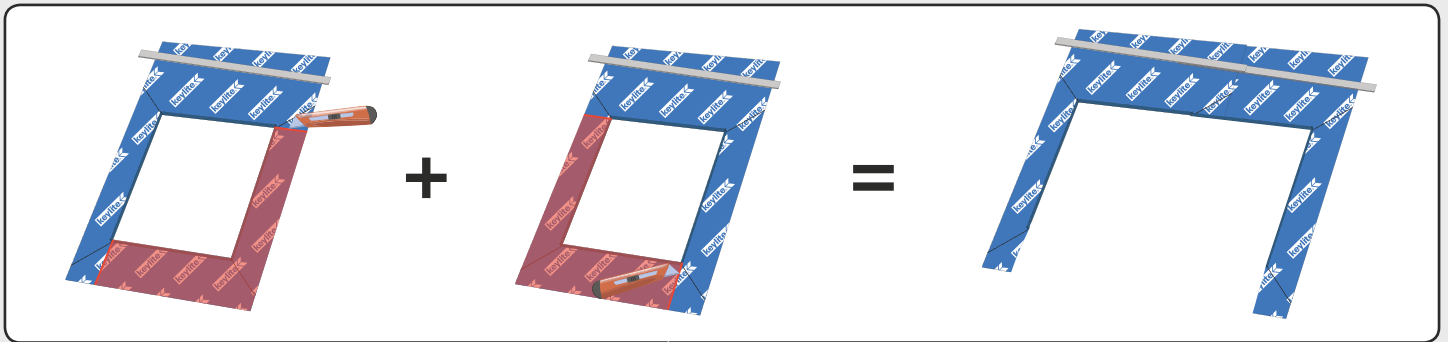
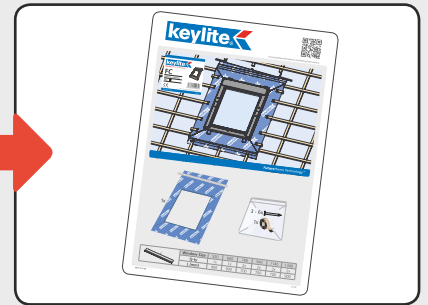
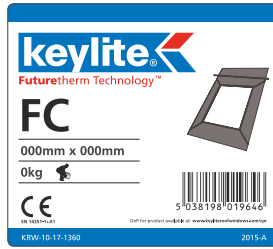
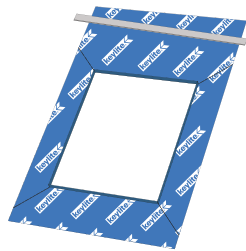
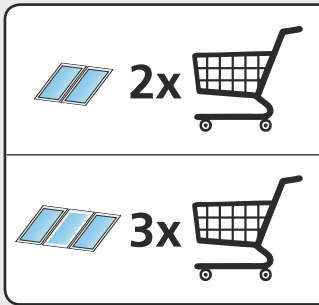
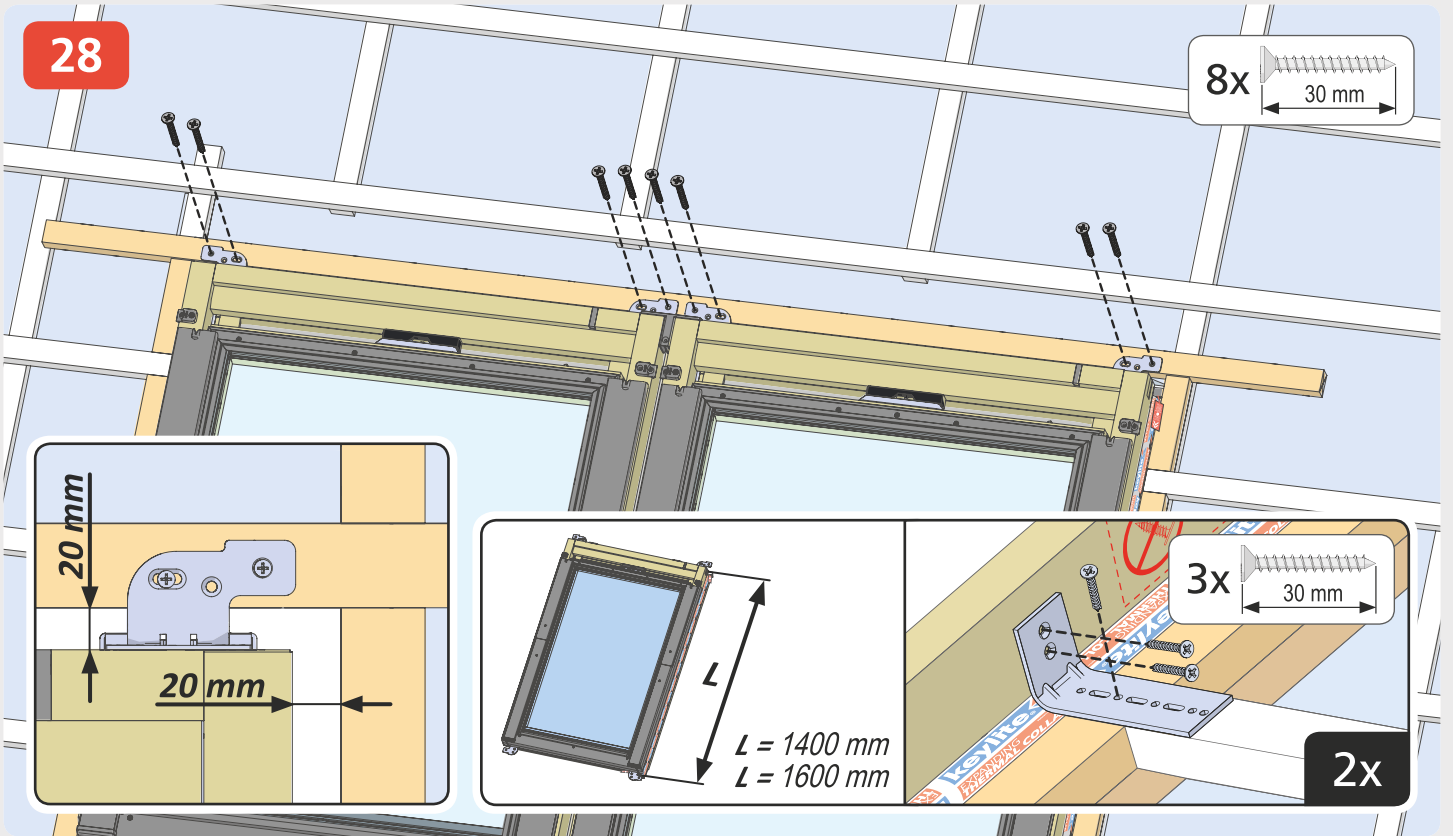

29

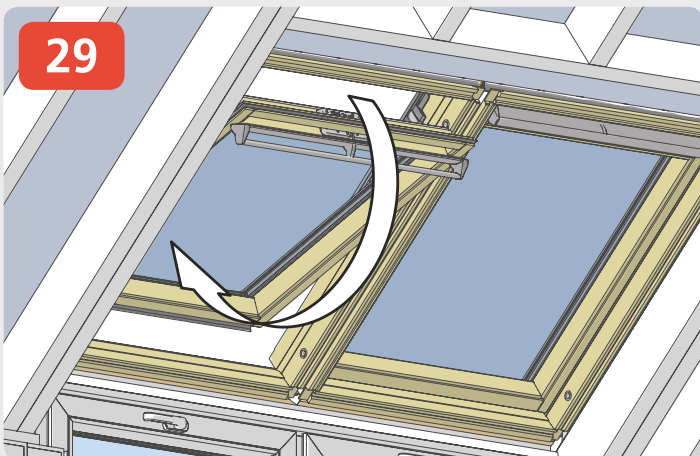

30

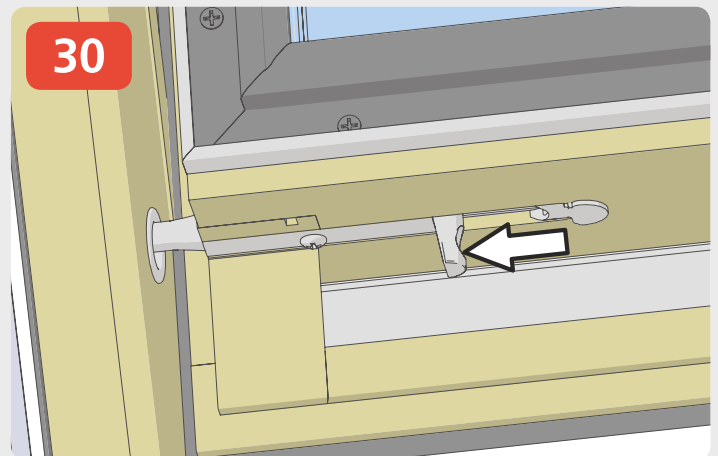

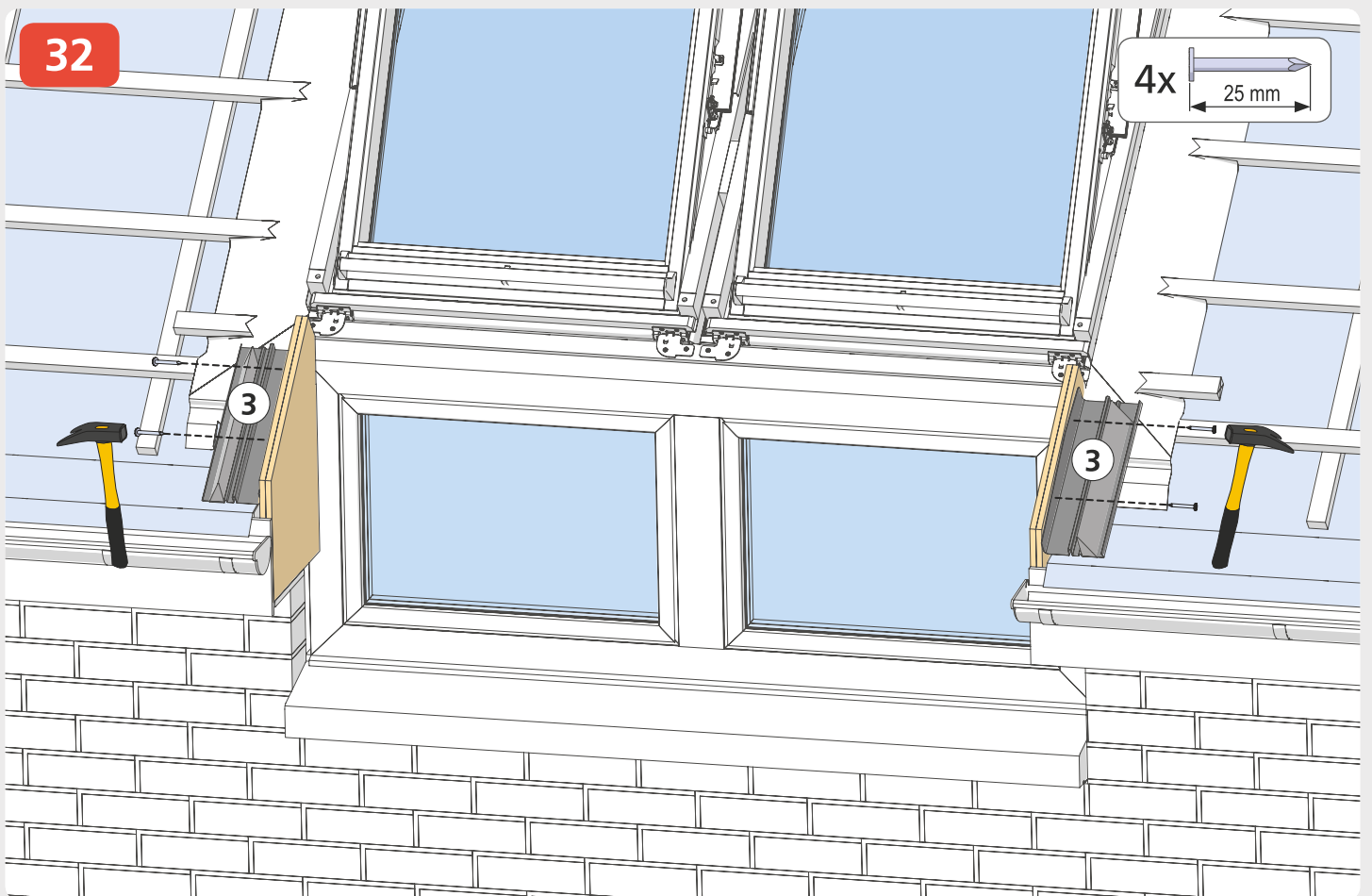
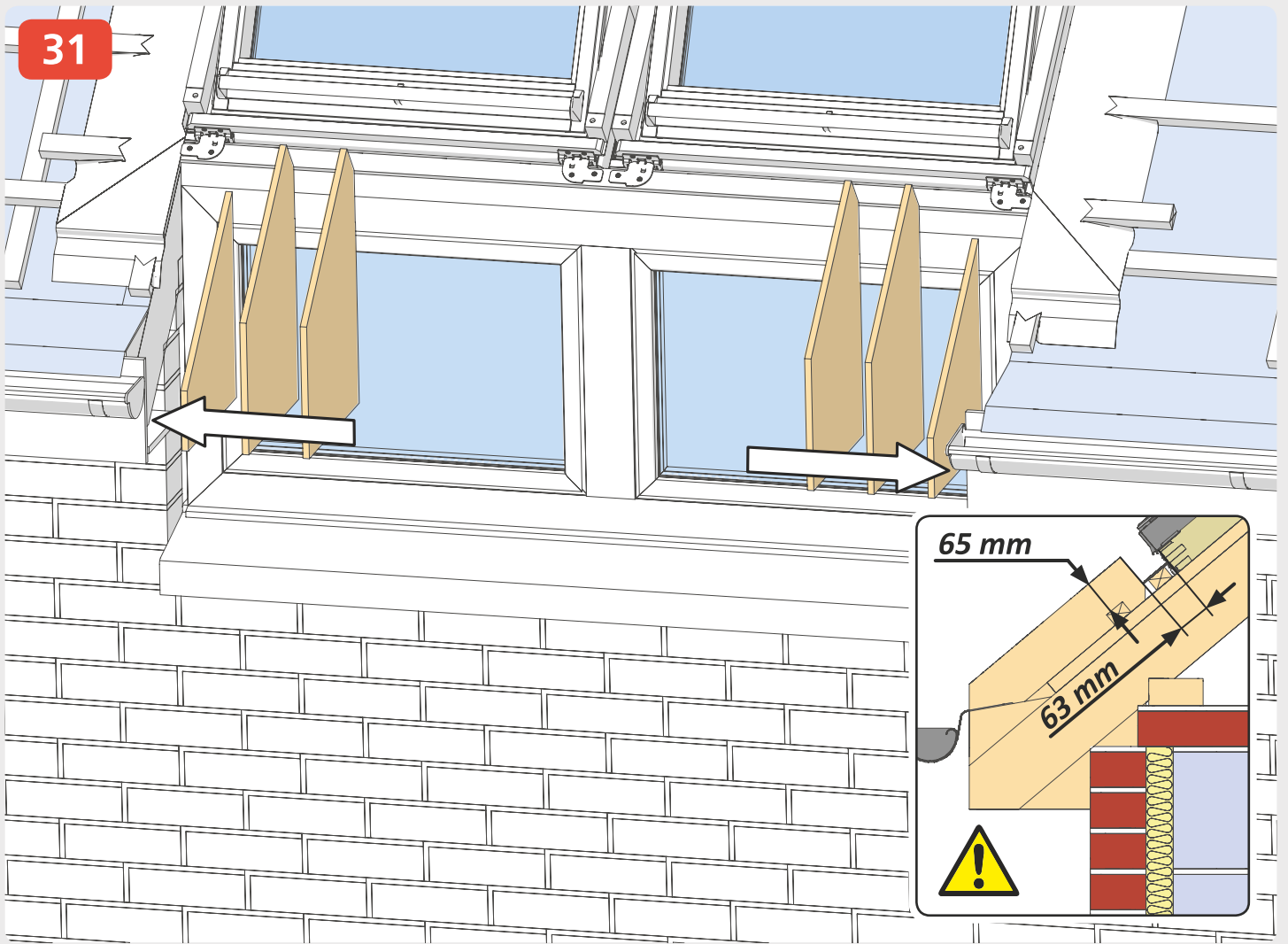

33

4x 25 mm

6.1

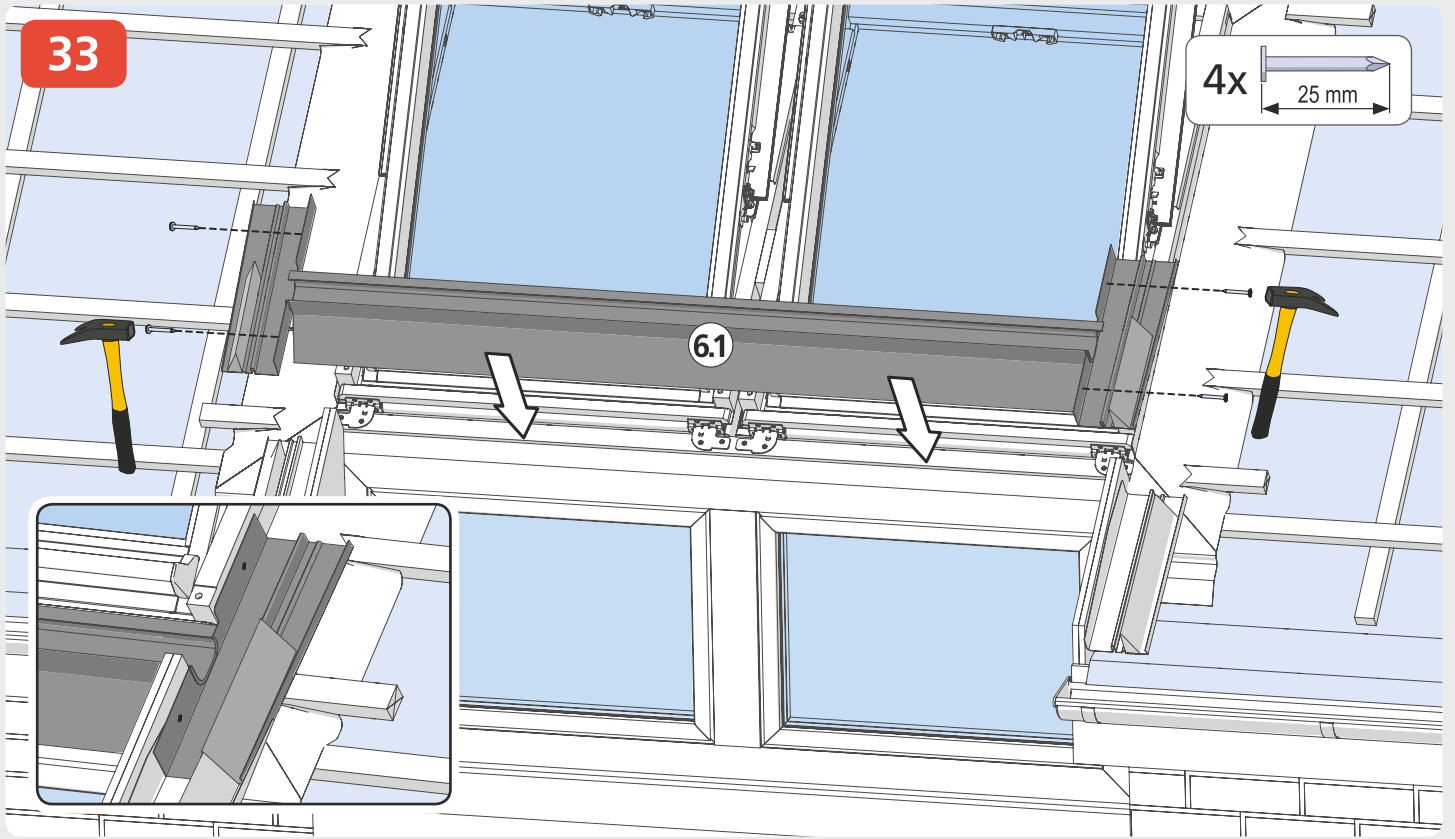

34

6x 30 mm

2

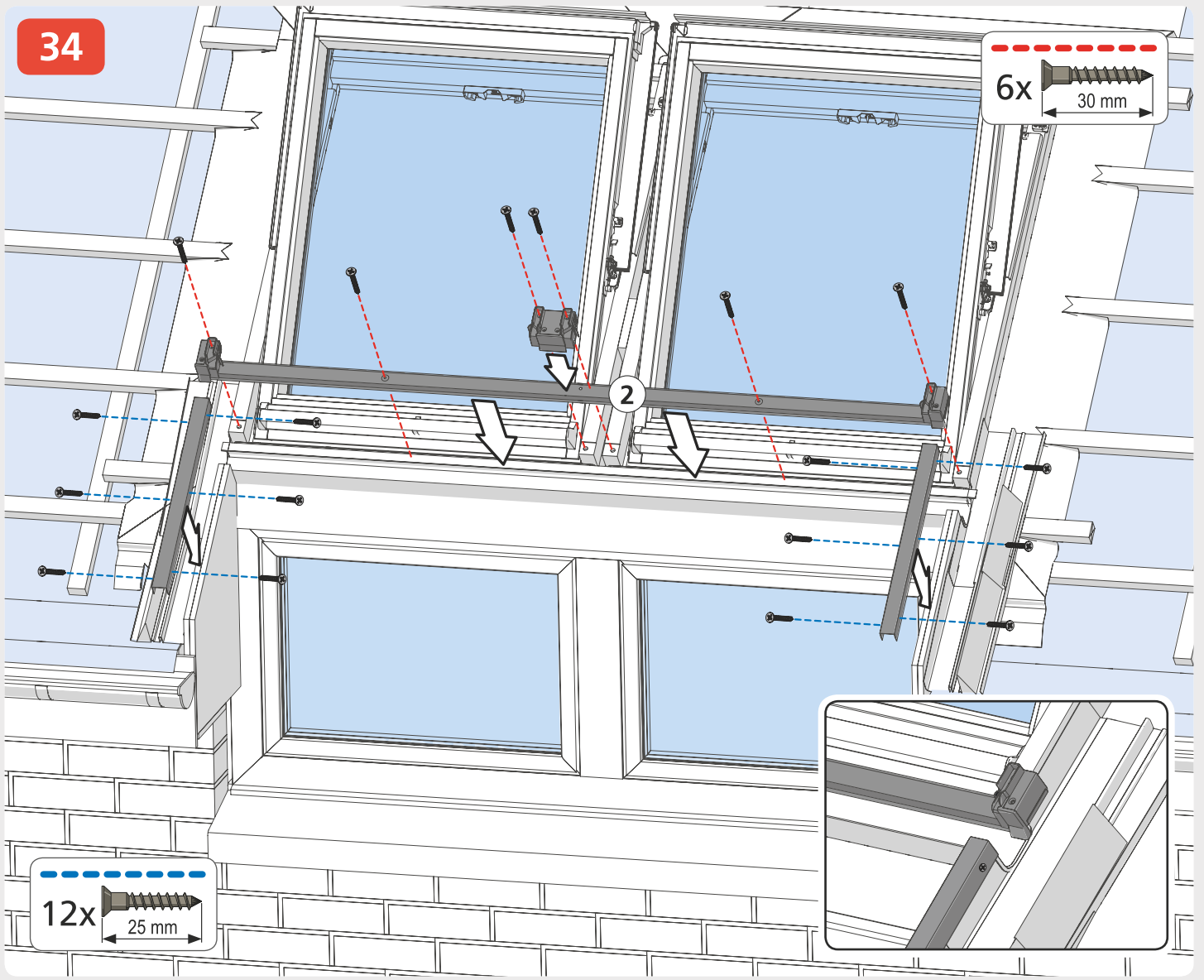

12x 25 mm

35

2x 30 mm

4.1

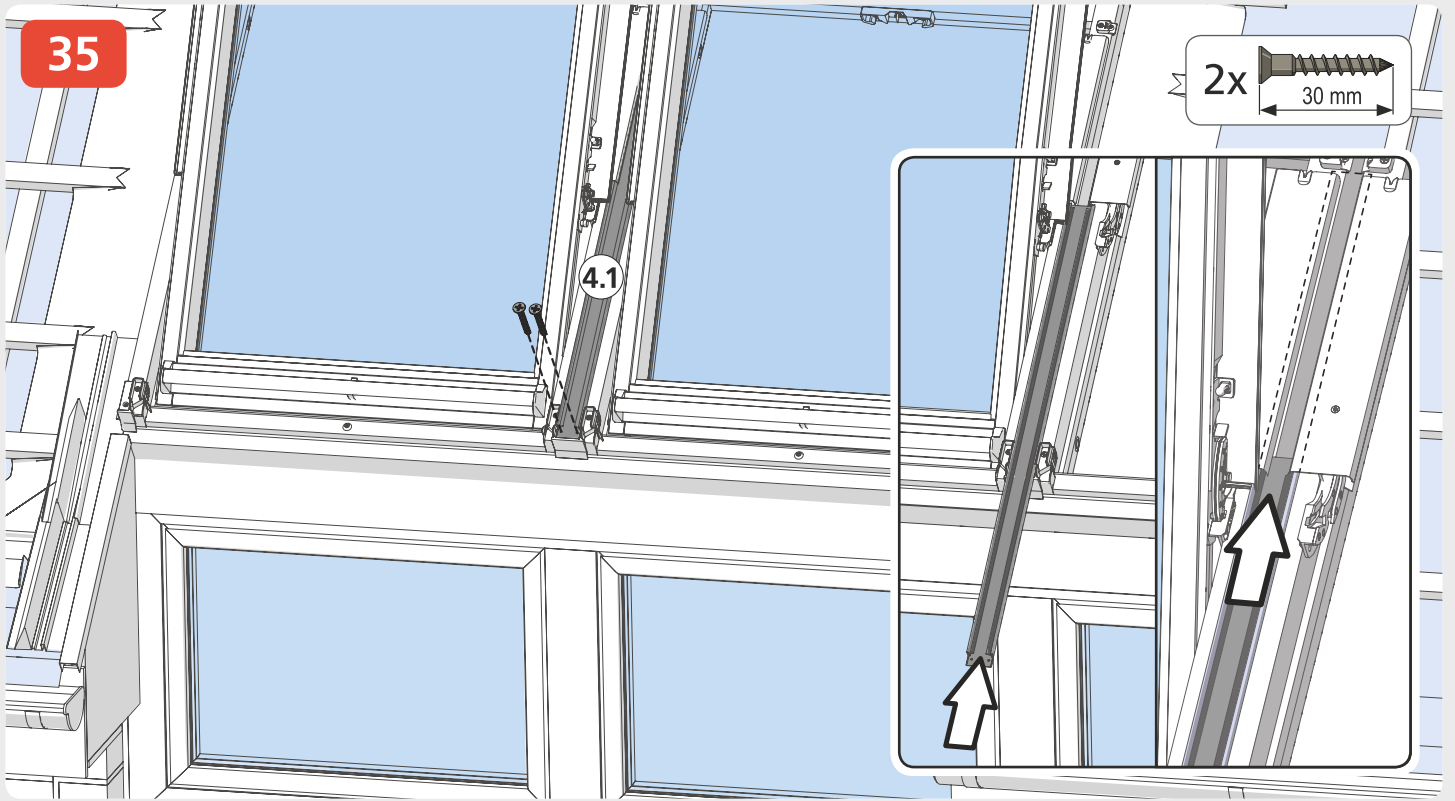

TH/FE

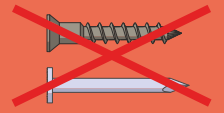
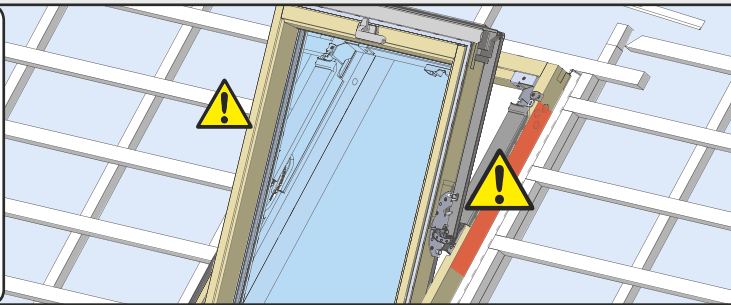

max. 7 mm



36

6x 25 mm

3

3

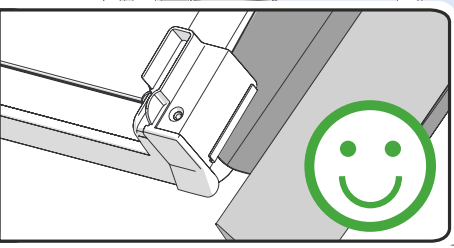
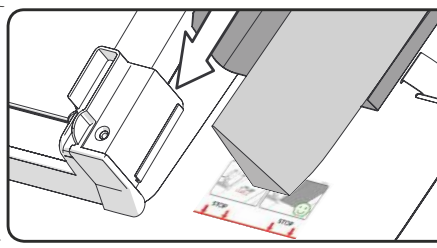
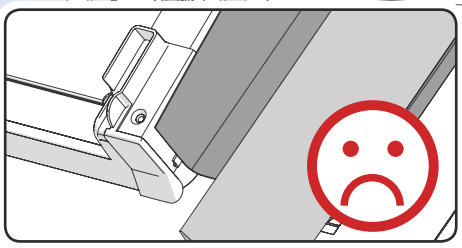
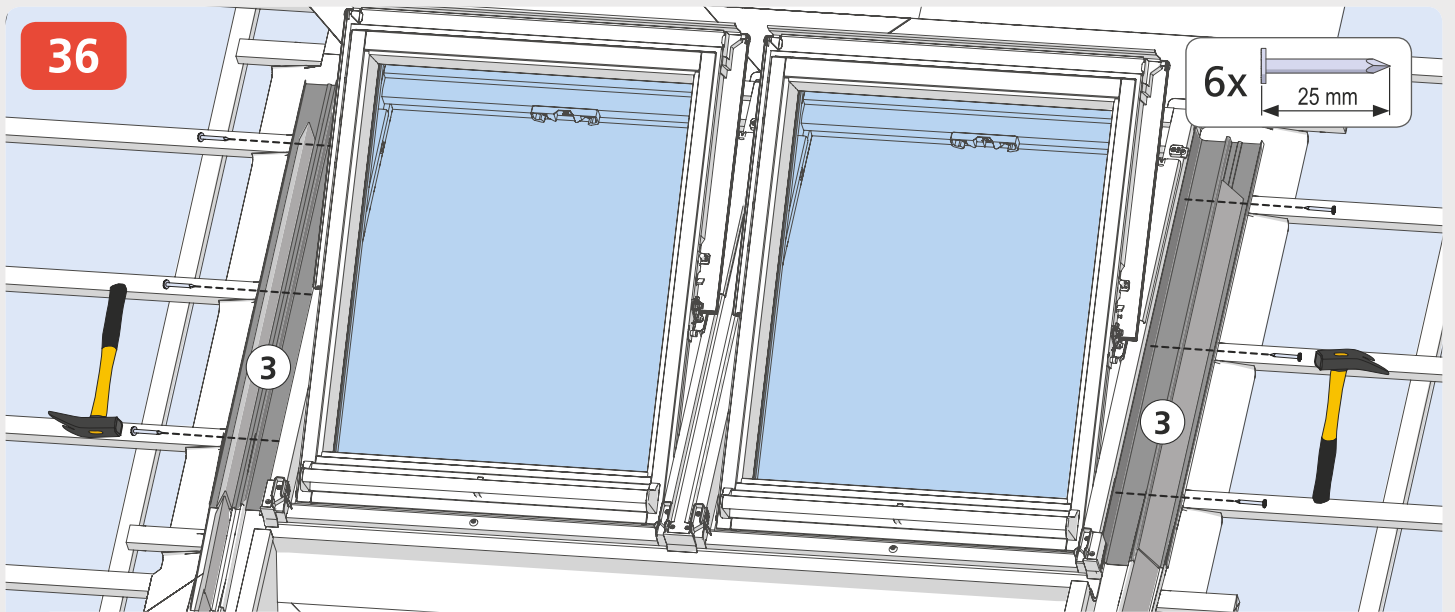

37

6x 

6x 

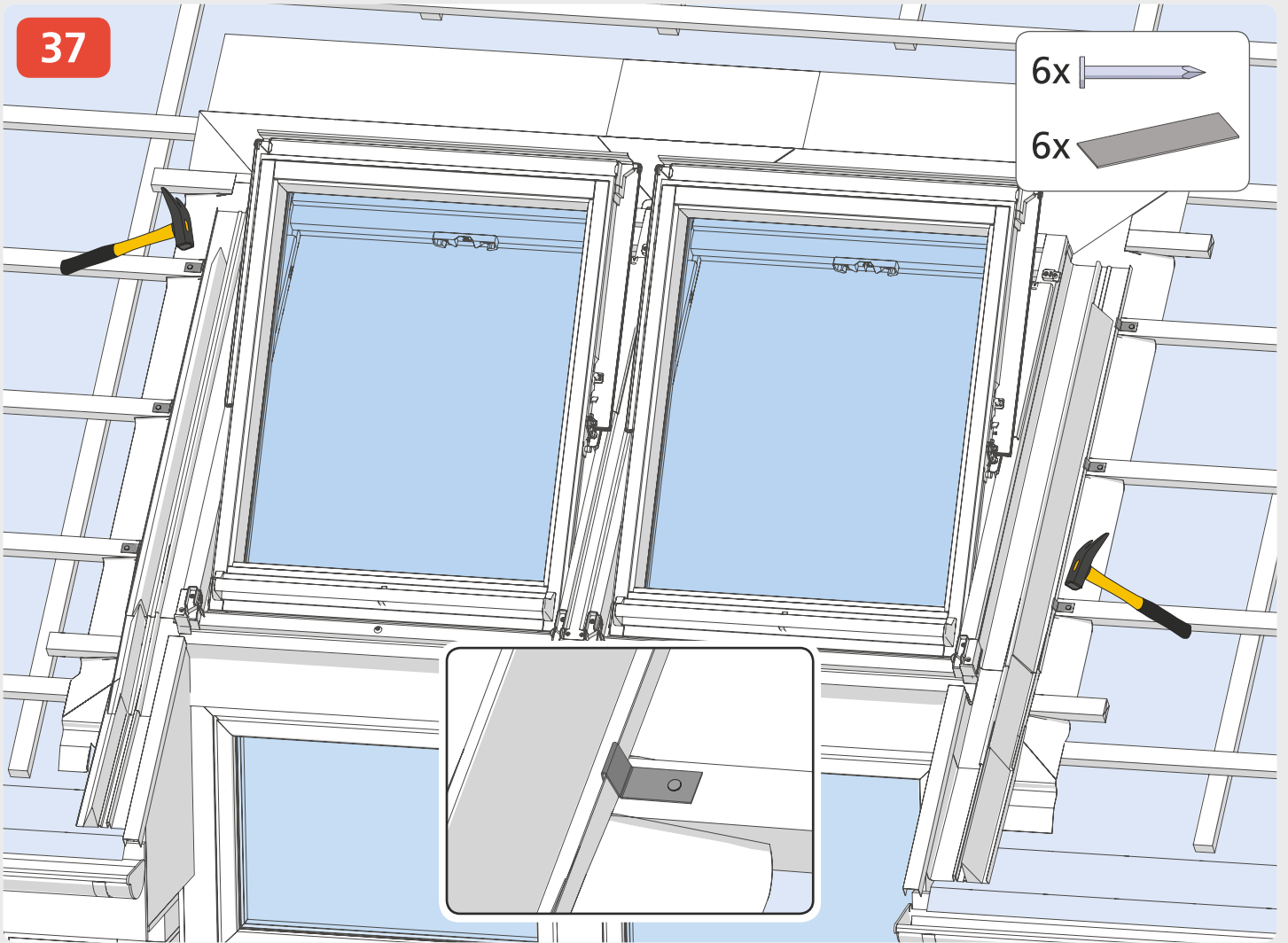

38

2x  30 mm

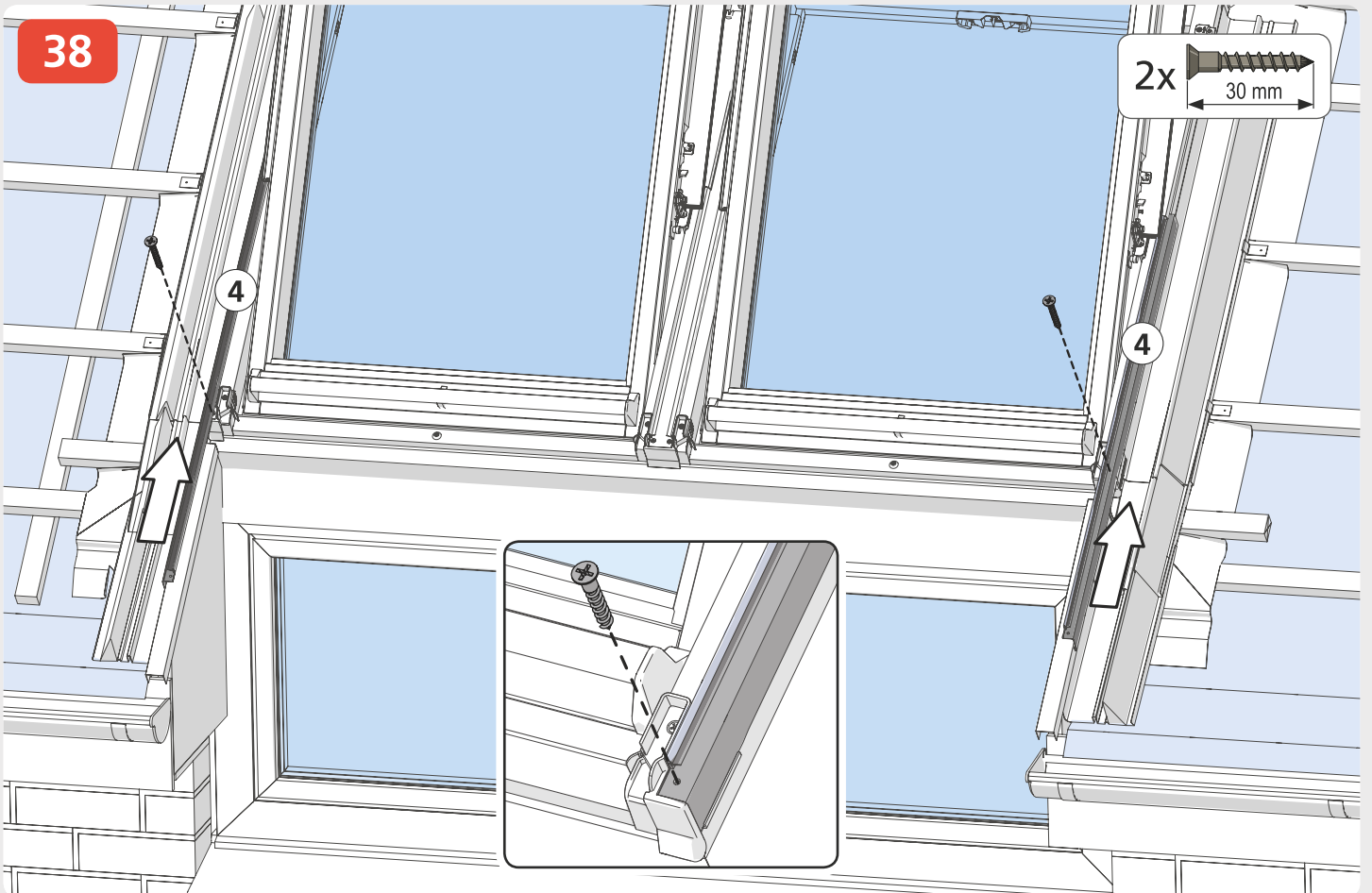

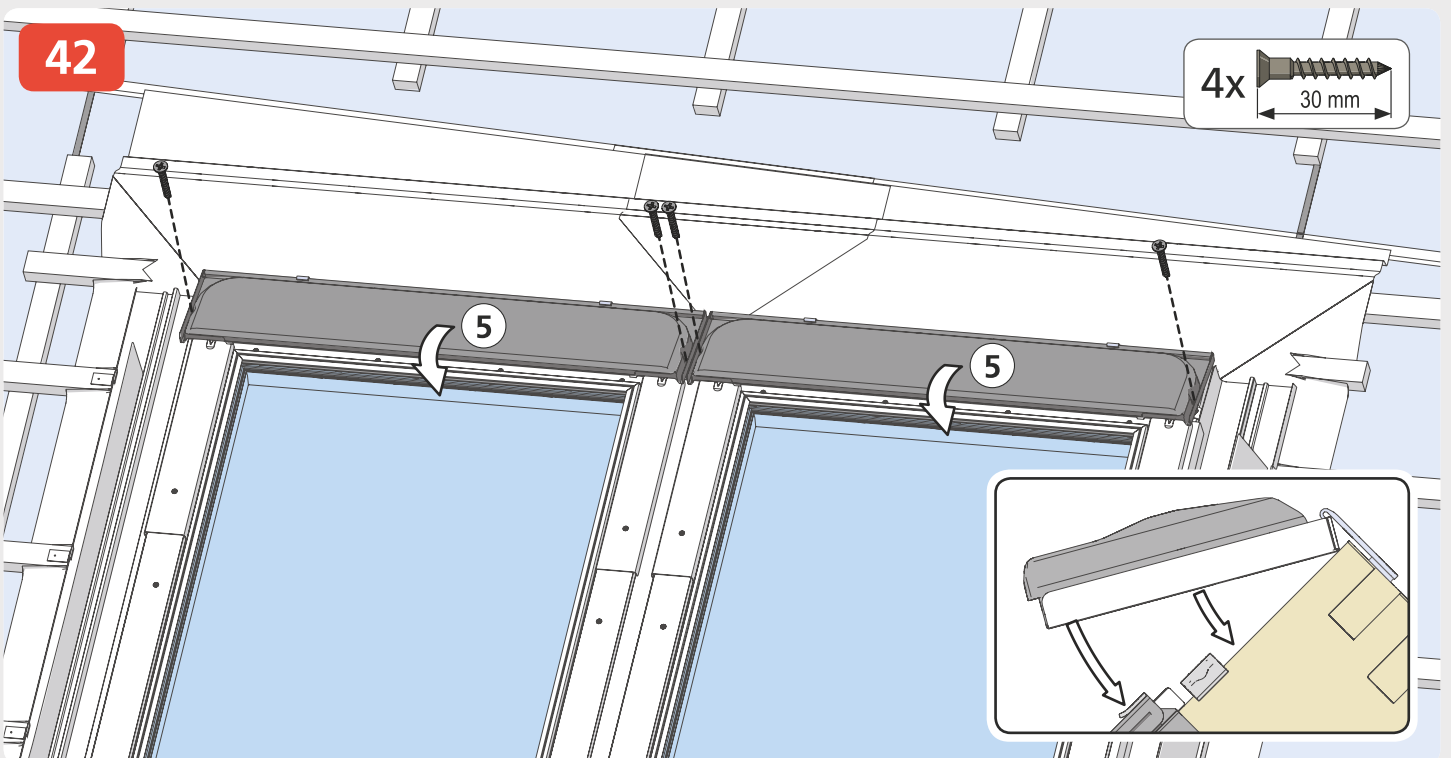
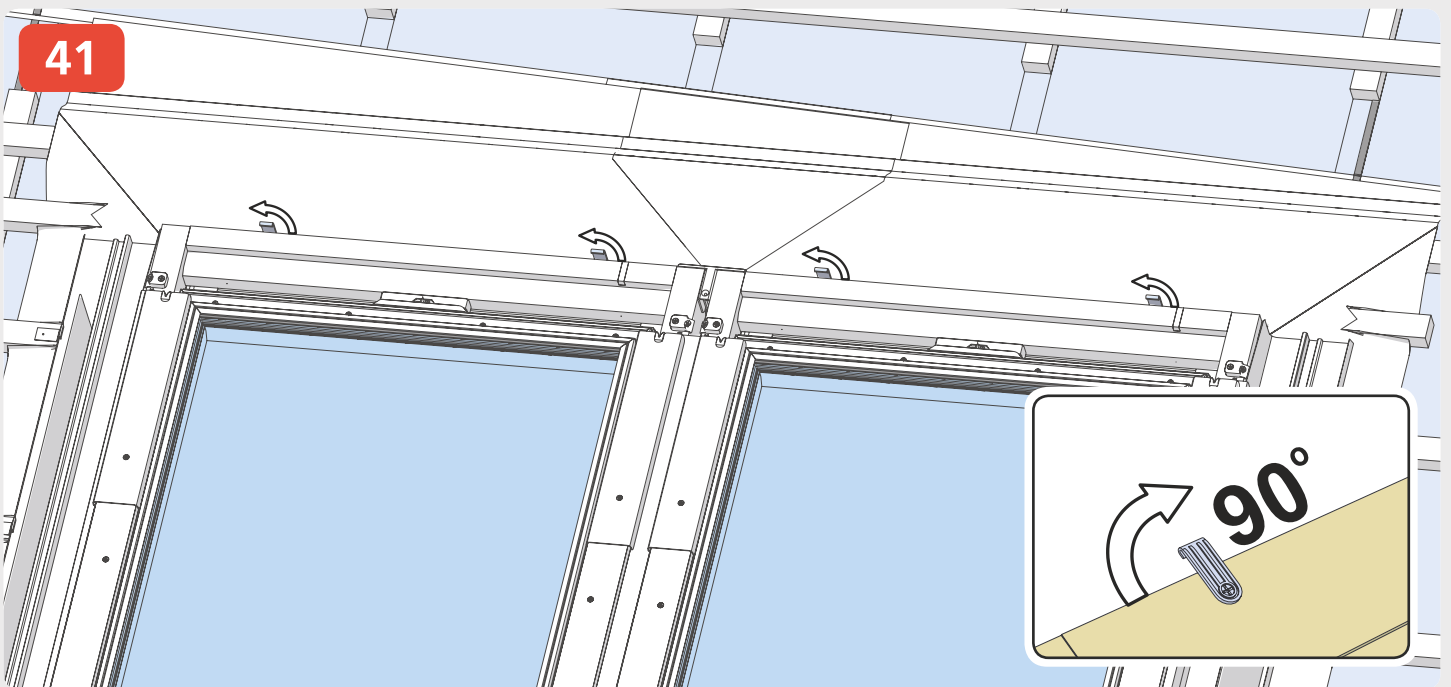
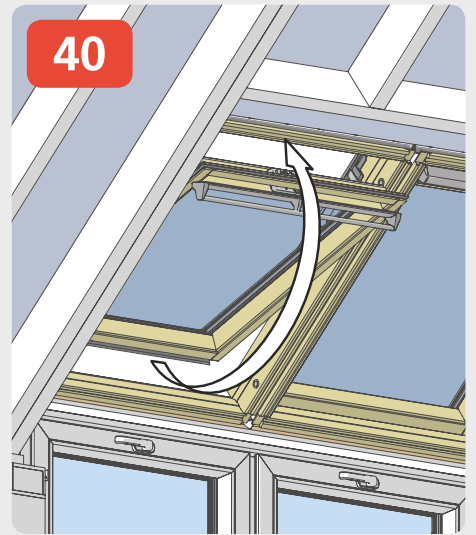
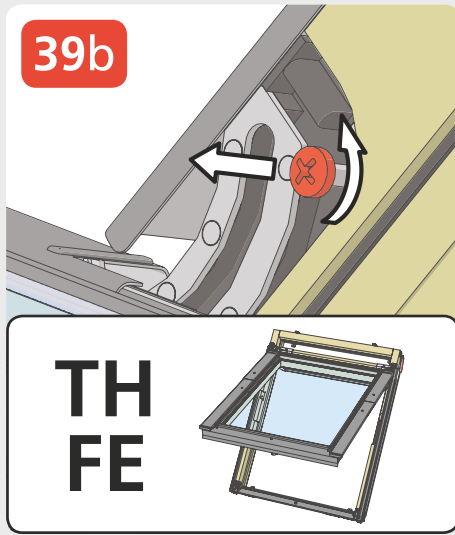
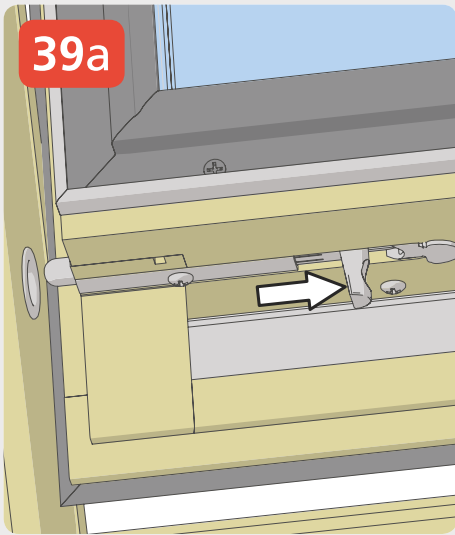

43

2x  30 mm

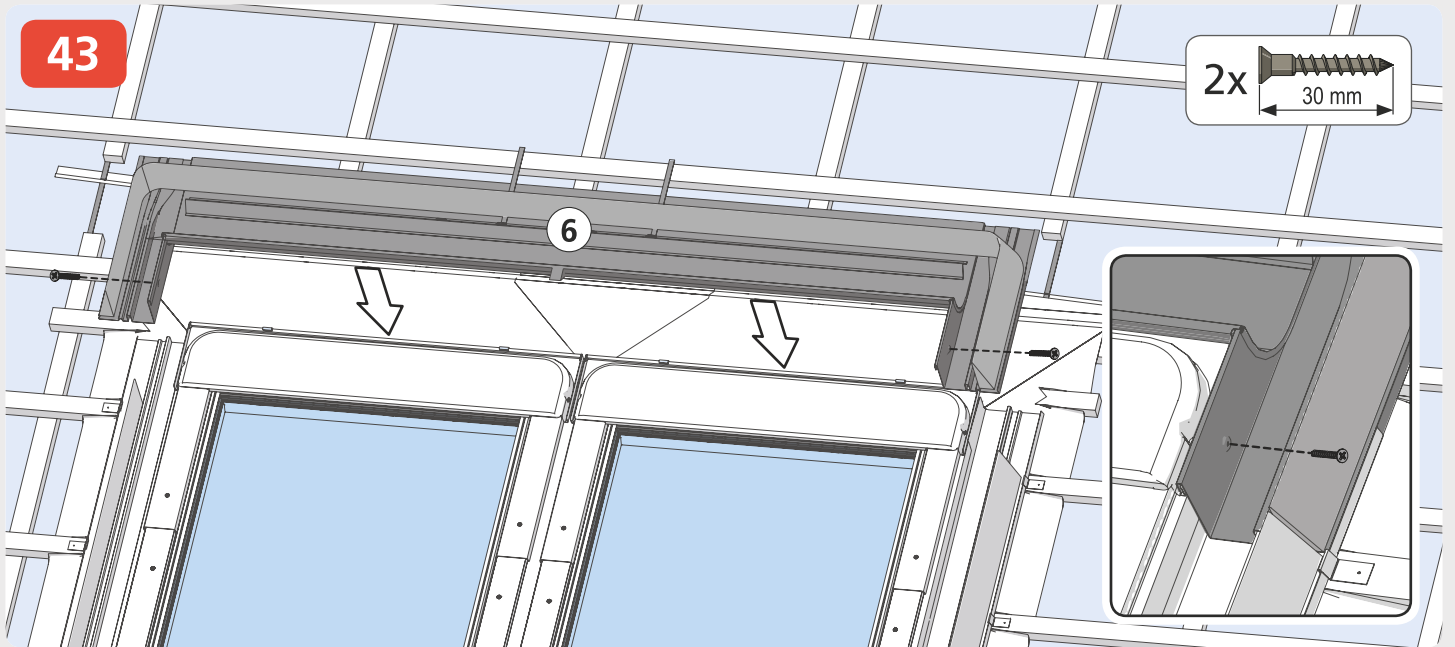

44

1x  60 mm

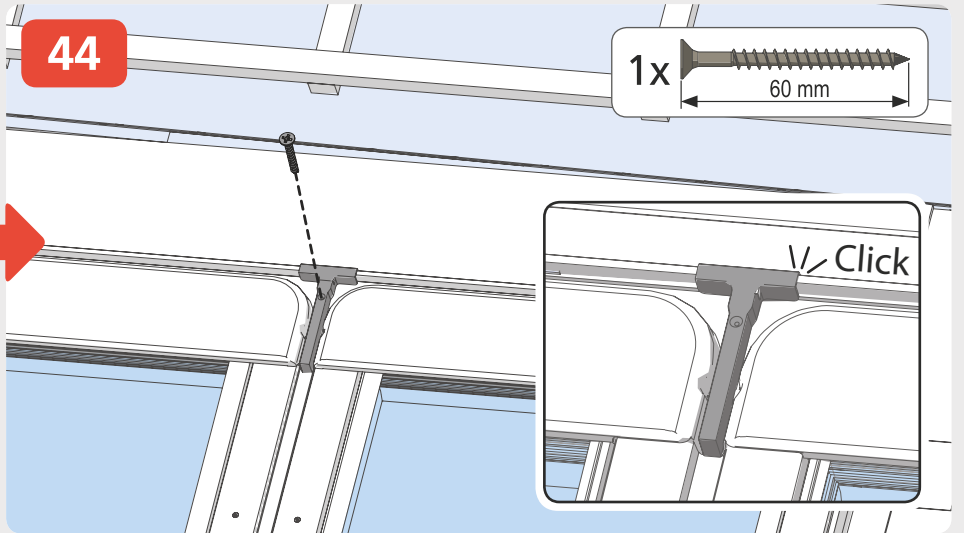
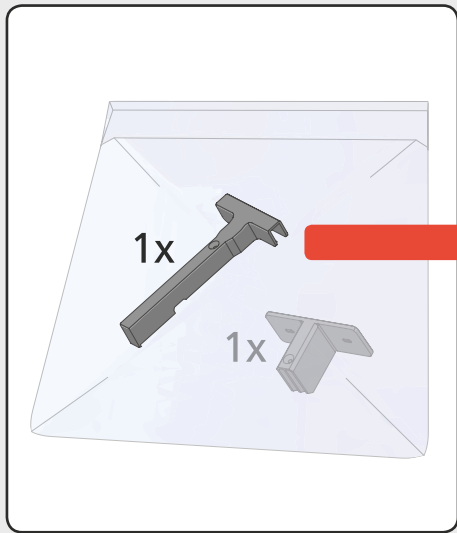

45

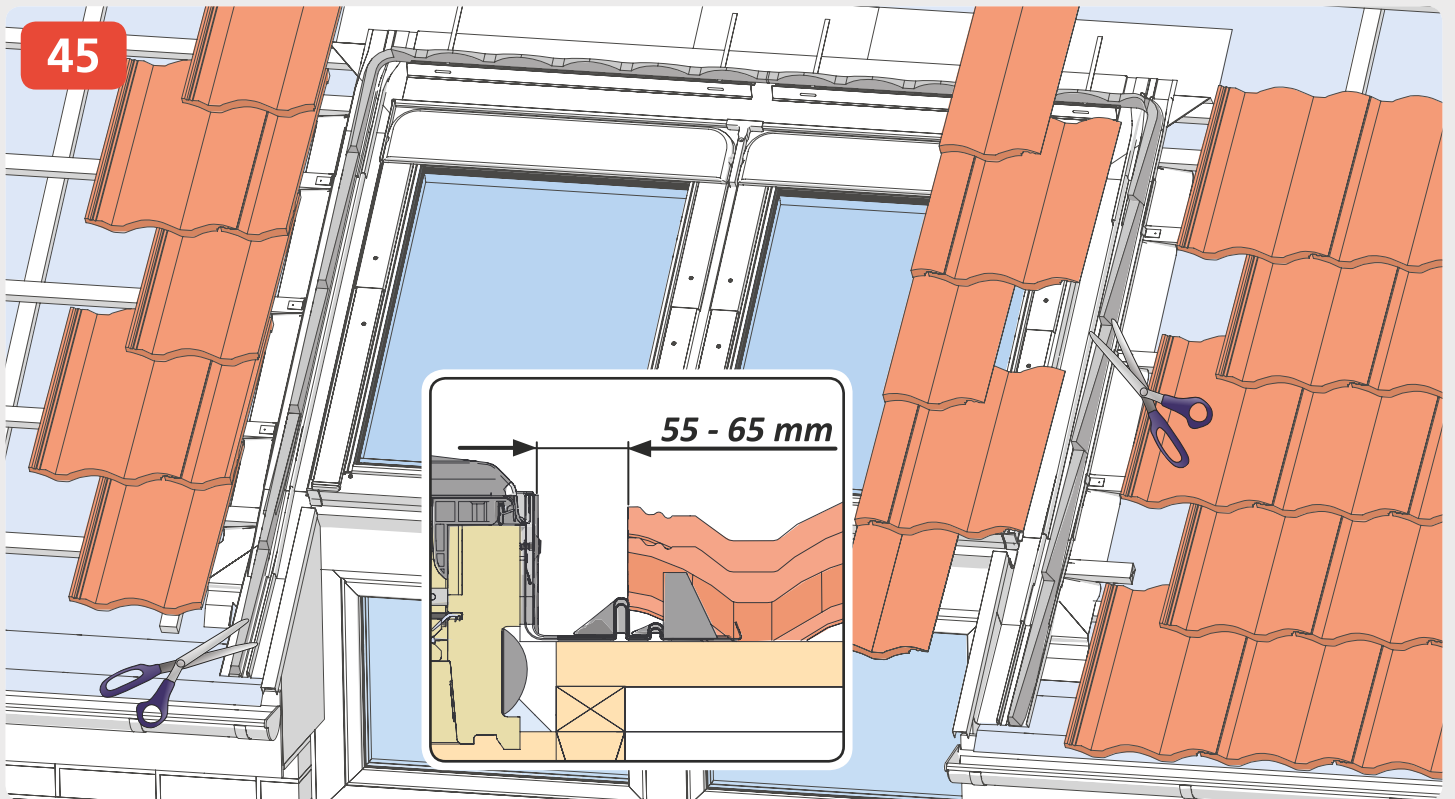

46



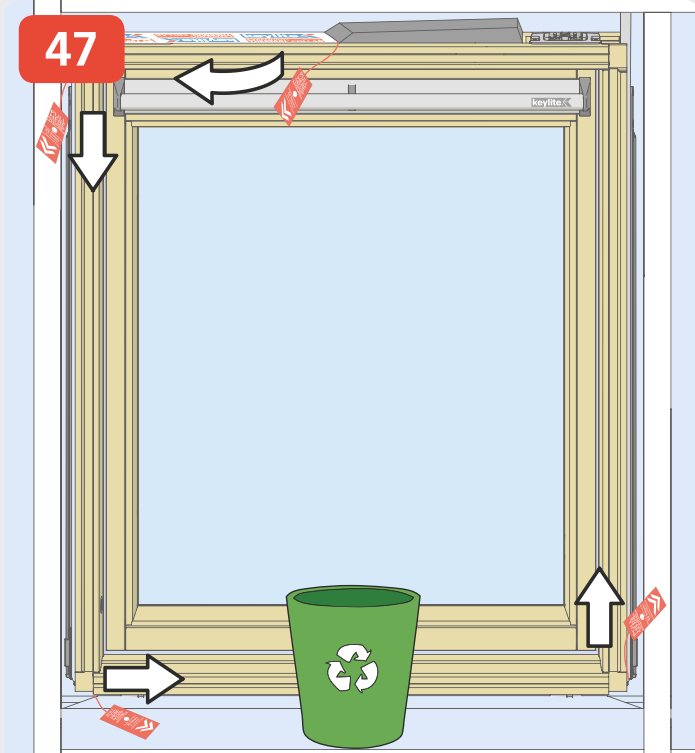

47

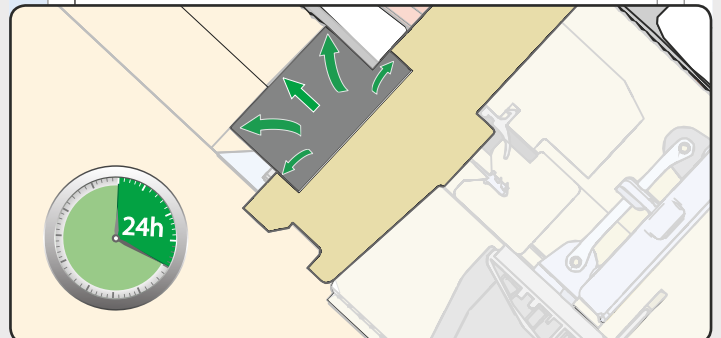
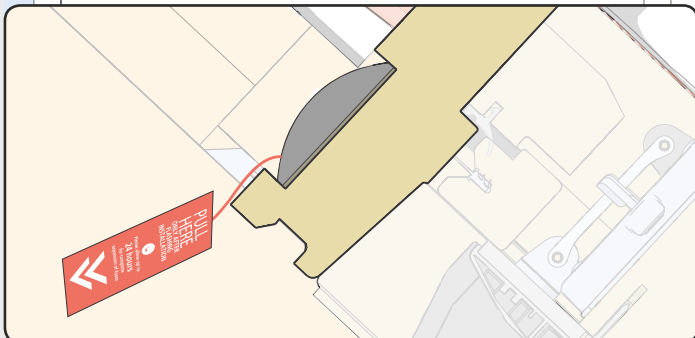
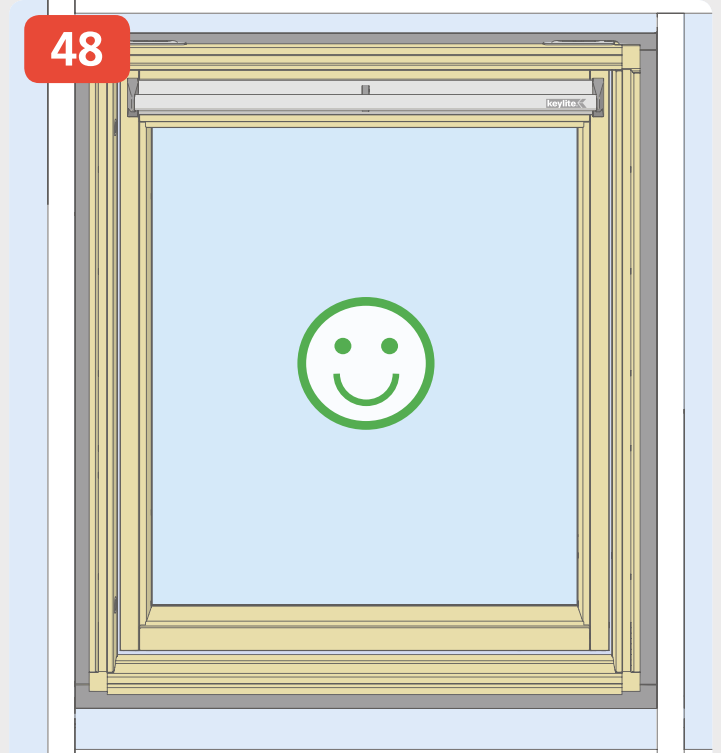

48



49

5x  / 

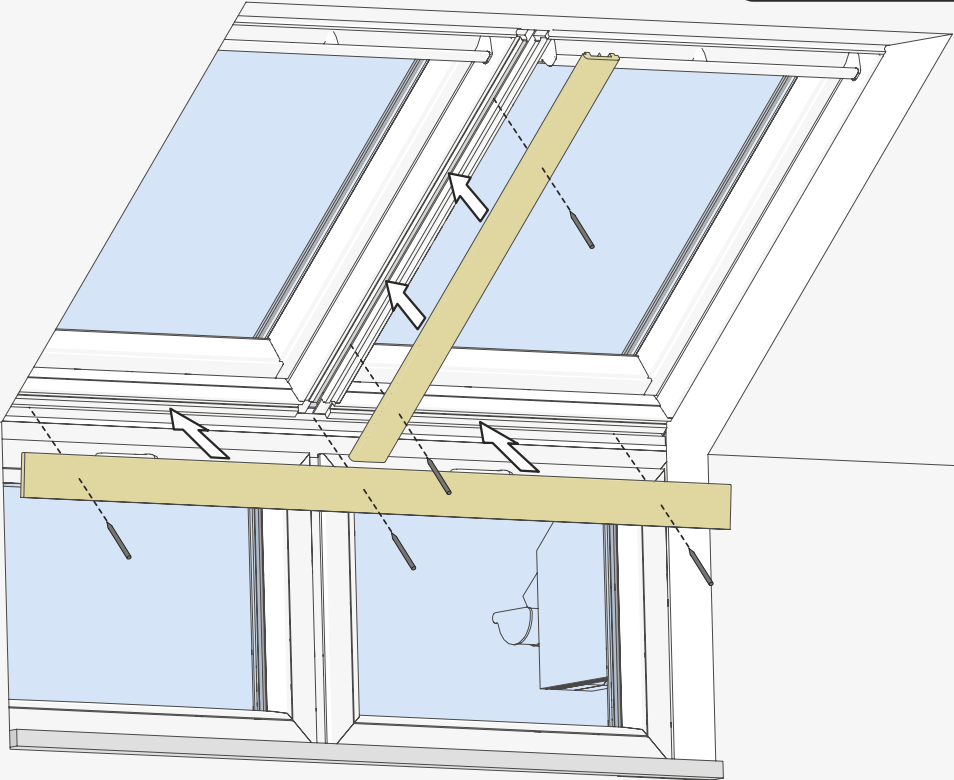

50

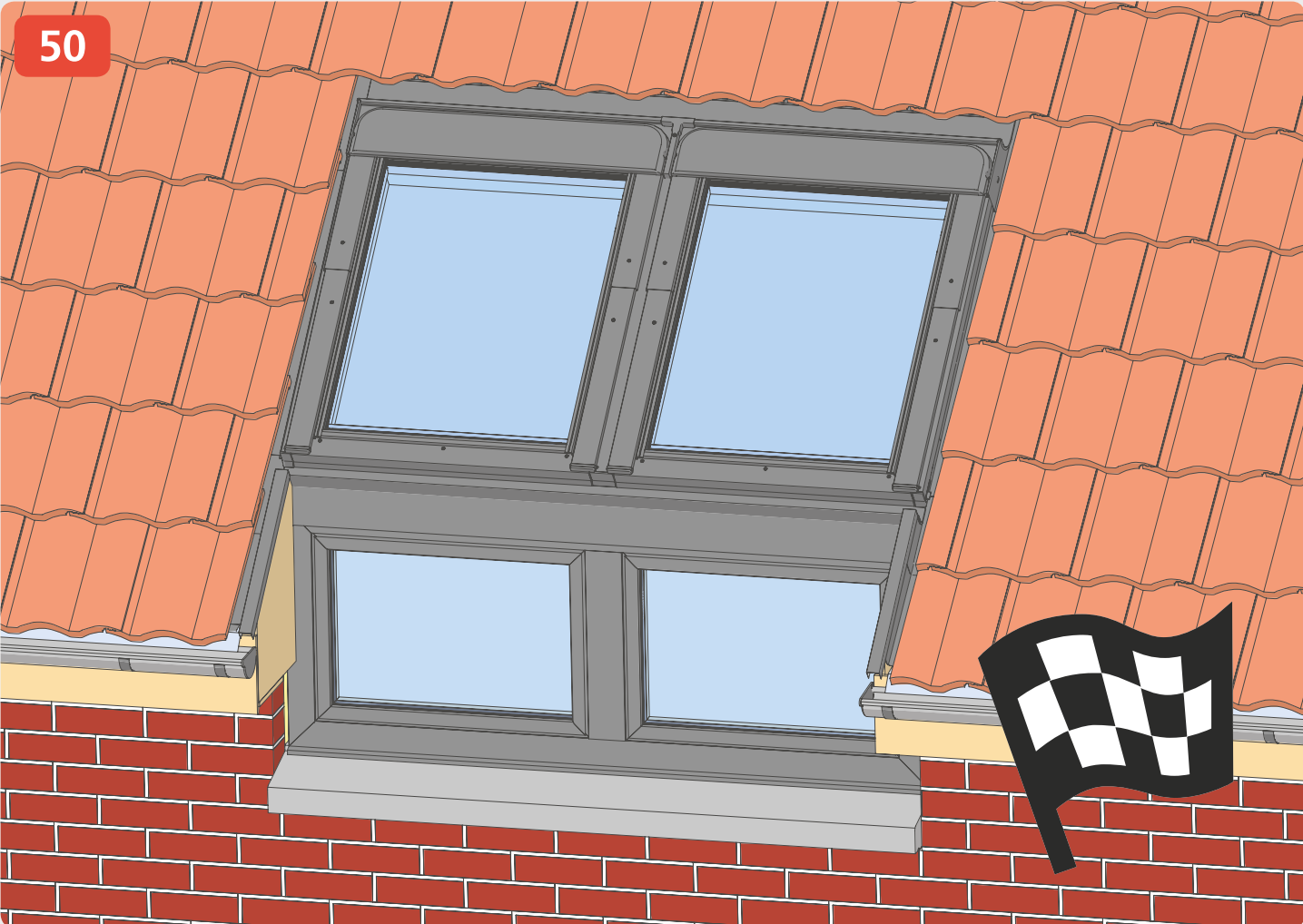



www.keyliteroofwindows.com